

**EFFECT OF PULL 5 EC AND 2,4-D ON WEED KILLING
EFFICACY TOWARDS PHENOLOGY AND YEILD OF
MUNGBEAN**

NEGAR SULTANA



**DEPARTMENT OF AGRONOMY
SHER-E-BANGLA AGRICULTURAL UNIVERSITY
DHAKA-1207**

JANUARY-2015

**EFFECT OF PULL 5 EC AND 2,4-D ON WEED KILLING
EFFICACY TOWARDS PHENOLOGY AND YEILD OF
MUNGBEAN**

**BY
NEGAR SULTANA
REGISTRATION NO: 09-03497**

A Thesis
*Submitted to the Faculty of Agriculture,
Sher-e-Bangla Agricultural University, Dhaka,
in partial fulfillment of the requirements
for the degree of*

**MASTER OF SCIENCE
IN
AGRONOMY**

SEMESTER: JANUARY–JUNE, 2015

Approved by:

Dr. H. M. M. Tariq Hossain
Professor
Supervisor

Dr. Md. Abdullahil Baque
Professor
Co-supervisor

Prof. Dr. Md. Fazlul Karim
Chairman
Examination Committee

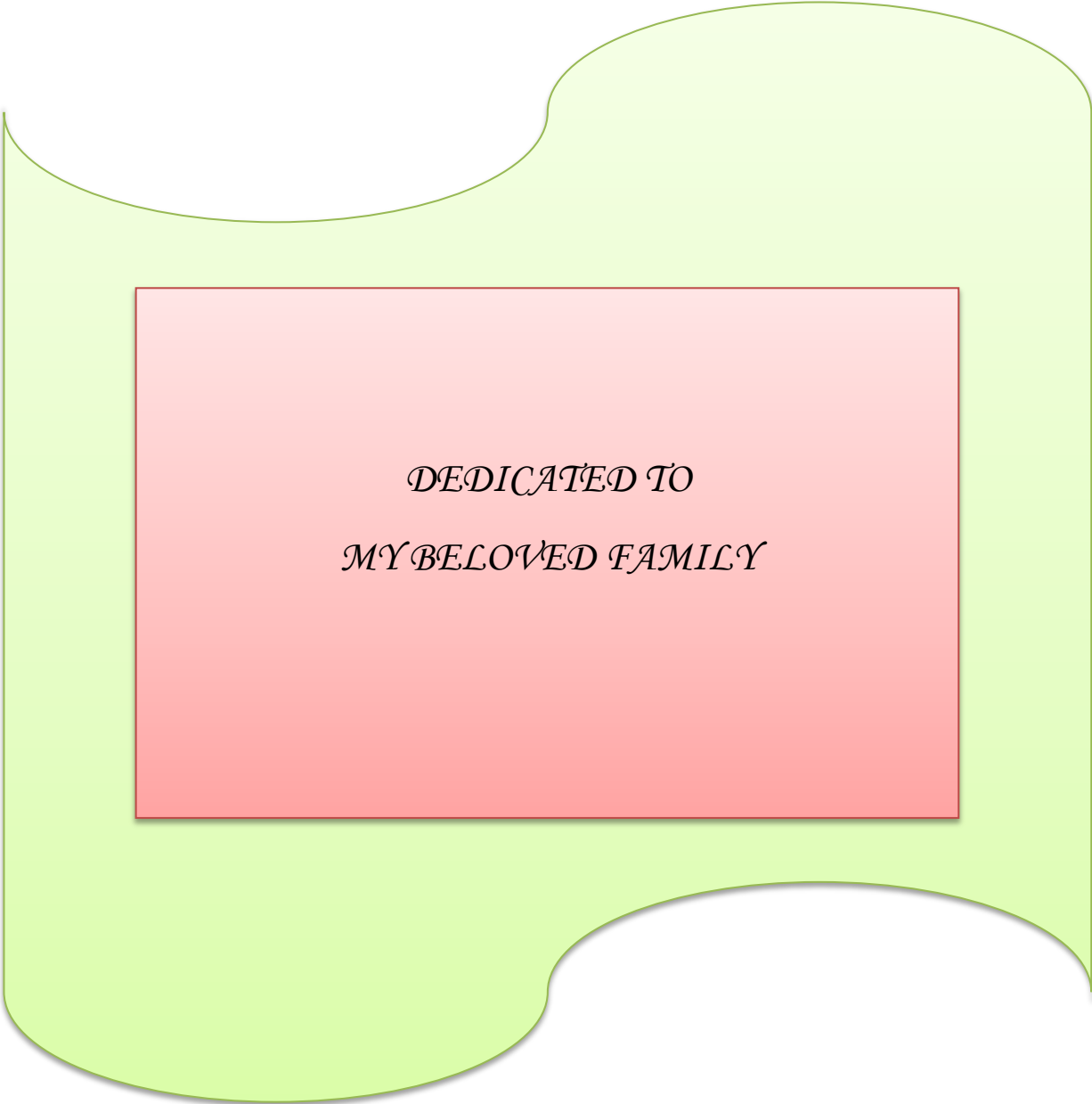

*DEDICATED TO
MY BELOVED FAMILY*



DEPARTMENT OF AGRONOMY

Sher-e-Bangla Agricultural University

Sher-e-Bangla Nagar

Dhaka-1207

CERTIFICATE

*This is to certify that thesis entitled, “EFFECT OF PULL 5 EC AND 2,4-D ON WEED KILLING EFFICACY TOWARDS PHENOLOGY AND YEILD OF MUNGBEAN” submitted to the Faculty of Agriculture, Sher-e-Bangla Agricultural University, Dhaka, in partial fulfillment of the requirements for the degree of **MASTER OF SCIENCE (M.S.) in AGRONOMY**, embodies the result of a piece of bonafide research work carried out by **NEGAR SULTANA**, Registration no. **09-03497** under my supervision and guidance. No part of the thesis has been submitted for any other degree or diploma.*

I further certify that such help or source of information, as has been availed of during the course of this investigation has duly been acknowledged.

Date:
Place: Dhaka, Bangladesh

Dr. H. M. M. Tariq Hossain
Professor
Department of Agronomy
Sher-e-Bangla Agricultural University,
Dhaka-1207

ACKNOWLEDGEMENTS

All praises are laid upon the almighty Allah who is the Supreme Creator and given the author His kind blessing to complete this piece of study. The author also seems it a proud privilege to express his deepest sense of gratitude to Him to let him of successful completion of his Master of Science degree.

It is a great pleasure for the author to express profound thankfulness to his respected parents, who entitled much hardship inspiring for prosecuting his studies, thereby receiving proper education. It is a proud privilege to express his deepest sense of gratitude to them to let him of successful completion of his Master of Science degree.

The author is much pleased to express his sincere appreciation and profound gratitude to his respective supervisor Prof. Dr. H. M. M. Tariq Hossain, Department of Agronomy, Sher-e-Bangla Agricultural University, Dhaka for his dynamic guidance, constant encouragement, constructive criticism and valuable suggestions not only during the preparation of the thesis but also during the entire period of the work.

It is a great pleasure for the author to express his deep sense of gratitude and sincere regard to the research co-supervisor, Prof. Dr. Md. Abdullahil Baque, Department of Agronomy, Sher-e-Bangla Agricultural University, Dhaka for his adept guidance, supervision, kind cooperation, and valuable suggestions in preparation of the thesis.

The author is highly grateful to Prof. Dr. Md. Fazlul Karim, Chairman, Department of Agronomy, Sher-e-Bangla Agricultural University, Dhaka along with all the teachers and staff members of the Department of Agronomy, Sher-e-Bangla Agricultural University for their co-operation during the period of the study.

The author also expresses heartfelt thanks to all the teachers of the Department of Agronomy, SAU, for their valuable suggestions, instructions, cordial help and encouragement during the period of the study.

The author wish to extend his special thanks to his classmates and friends Pavel Khan Pappu, Faiz Muhammad Al-Noman ,Tahmina Akter Rina, Najnin Jahan and Nusrat Jahan Nipa for their keen help as well as heartiest co-operation and encouragement.

The author express his heartfelt thanks to his relatives and well-wishers who continuously prayed for his success and without whose love, affection, inspiration and sacrifice this work would not have been completed.

May Allah bless and protect them all.

The Author

EFFECT OF PULL 5 EC AND 2, 4-D ON WEED KILLING EFFICACY TOWARDS PHENOLOGY AND YIELD OF MUNGBEAN

ABSTRACT

A field experiment was conducted at the Agronomy field of Sher-e-Bangla Agricultural University, Sher-e-Bangla Nagar, Dhaka during the period from April 2015 to June 2015 to study the efficacy of Pull 5 EC and 2, 4-D herbicides on phenology and yield of BARI mungbean 6. The experiment comprised of 7 treatments viz. Weedy check (T₁), spraying of Pull 5 EC @ 550 ml /ha at 15 and 25 DAS (T₂), spraying of Pull 5 EC @ 600 ml /ha at 15 and 25 DAS (T₃) , spraying of Pull 5 EC @ 650 ml /ha at 15 and 25 DAS (T₄), spraying of @ Pull 5 EC 700 ml/ ha at 15 and 25 DAS (T₅), spraying of Pull 5 EC @ 750 ml /ha at 15 and 25 DAS (T₆) and spraying 2,4-D 650 ml /ha at 15 and 25 DAS (T₇) . Result showed that the tallest plant (36.78 cm) at harvest was obtained from spraying of Pull 5 EC @ 600 ml /ha at 15 and 25 DAS (T₃) and the highest dry weight of plant was observed in spraying of Pull 5 EC @ 650 ml /ha at 15 and 25 DAS (T₄). At 25 DAS, the maximum number of weeds was found in (T₇) spraying 2, 4-D 650 ml /ha at 15 and 25 DAS and at 35 DAS in (T₁) Weedy check. The highest weed control efficiency of 78.10 % and 78.42 % were found at 25 and 35 DAS respectively with (T₃) spraying of Pull 5 EC @ 600 ml /ha at 15 and 25 DAS. As far as seed yield was concerned, the highest seed yield (1.64 t/ha) was obtained from (T₄) spraying of Pull 5 EC @ 650 ml /ha at 15 and 25 DAS followed by (T₃) spraying of Pull 5 EC @ 600 ml /ha at 15 and 25 DAS (1.6 t/ha). On the other hand spraying of 2, 4-D had negative impact on growth and yield of mungbean.

LIST OF CONTENTS

CHAPTER	TITLE	PAGE
	ACKNOWLEDGEMENT	i-ii
	ABSTRACT	iii
	LIST OF CONTENTS	iv-vii
	LIST OF TABLES	viii
	LIST OF FIGURES	ix
	LIST OF APPENDICES	X
	LIST OF ABBREVIATION	xi-xii
1	INTRODUCTION	1
2	REVIEW OF LITERATURE	3
2.1	Effect of herbicide on crop growth	3
2.1.1	Plant height	3
2.1.2	Effect on plant biomass	3
2.2	Effect on Weed attributes	4
2.2.1	Weed Biomasses	5
2.2.2	Weed Density	6
2.2.3	Weed control efficiency	7
2.3.	Effect on yield and yield attributing parameters:	7
2.3.1	Number of pod per plant	8
2.3.2	Pod length	8
2.3.3	1000 seed weight	8
2.3.4	Yield	9
3	MATERIALS AND METHODS	10
3.1	Site description	10
3.2	Agro-Ecological Region	10
3.3	Climate and weather	10
3.4	Soil	11
3.5	Crop / Planting material	11
3.6	Chemical criteria of herbicides under study	12
3.6.1	Chemical specification of quizalofop-p-ethyl	12
3.6.1.1	Composition	12
3.6.1.2	Chemical group	12

LIST OF CONTENTS (Contd.)

CHAPTER	TITLE	PAGE
3.6.1.3	Type of formulation	12
3.6.1.4	Mode of action	12
3.6.1.5	Safety period (pre-harvest interval)	12
3.6.1.6	Compatibility	12
3.6.1.7	Controlled weeds	13
3.6.2	The herbicide 2, 4-D	13
3.7	Treatments under Investigation	14
3.8	Detail of the experiment	14
3.8.1	Experimental treatments	14
3.8.2	Experimental design	14
3.9	Growing of crops	15
3.9.1	Land preparation	15
3.9.2	Fertilizer application	15
3.9.3	Seed Sowing	16
3.9.4	Emergence of seedling	16
3.10.	Intercultural Operation	16
3.10.1	Weeding and thinning	16
3.10.2	Irrigation and Drainage	17
3.10.3	Insect control	17
3.11	Determination of Maturity	17
3.12	Harvesting and Sampling	17
3.13	Threshing	17
3.14	Drying, Cleaning and Weighing	17
3.15	Recording of Data	18
3.16	Outlin eof data recording	18
i	Plant height (cm)	19
ii	Plant dry weight (gm)	19
iii	Days to Seedling Emergence	19
iv	Days t0 50% seedling Emergence	19
v	Days to 50 % Weed germination	19
vi	Days to 50% flowering	19

LIST OF CONTENTS (Contd.)

CHAPTER	TITLE	PAGE
vii	Days to harvesting	19
viii	Number of grass per plot	19
ix	Number of sedge weed per plot	20
x	Number of broad leaf weed per plot	20
xi	Weed biomass per plot	20
xii	Weed control efficiency	20
xiii	Number of pods plant ⁻¹	20
xiv	Pods length	20
xv	Shell weight per square meter	20
xvi	Weight of 1000-grains (g)	20
xvii	Seed yield	21
xviii	Grain yield (t ha ⁻¹)	21
xiv	Statistical analysis	21
4	RESULTS AND DISCUSSION	22
4.1.1	Plant height (cm)	22
4.1.2	Plant dry matter(gm)	23
4.2	Effect on Weed attributes	25
4.2.1	Efeect on number of grasses	27
4.2.2	Efeect on number of sedge weeds	28
4.2.3	Efeect on number of broad leaf weed	29
4.2.4	Efeect on total weed population	30
4.2.5	Effect on weed boimass	30
4.2.6	Weed control efficiency	31
4.2.6.1	Weed control efficiency on grasses	31
4.2.6.2	Weed control efficiency on sedge weed	31

LIST OF CONTENTS (Contd.)

CHAPTER	TITLE	PAGE
4.2.6.3	Weed control efficiency on broad leaf weed	31
4.2.6.4	Weed control efficiency on total weed population	32
4.3	Yield and yield contributing attributes	33
4.3.1	Shell weight per square meter	33
4.3.2	Pod length	33
4.3.3	Number of pod per plant	33
4.3.4	1000 grain weight	33
4.3.5	Grain yield per hectare	34
5	SUMMARY AND CONCLUSION	37
6	REFERENCES	42
7	APPENDICES	45

LIST OF TABLES

TABLE NO.	TITLE	PAGE
1	Herbicidal effect on plant height (cm)	24
2	Effect of different weed control methods on yield components of mungbean	33
3	Effect of different weed control methods on yield of mungbean	35
4	Weed control efficiency (WCE) of different weed control methods at different days after sowing	36

LIST OF FIGURES

FIGURE NO.	TITLE	PAGE
1	Herbicidal effect on plant biomass (g)	25
2	Herbicidal effect on number of grass per plot	26
3	Herbicidal effect on number of sedge weed per plot	27
4	Herbicidal effect on number of broad leaf weeds per plot.	28
5	Herbicidal effect on total weed population	29
6	Herbicidal effect on weed biomass	30

LIST OF APPENDICES

APPENDIX NO.	TITLE	PAGE
I	Map showing the experimental sites under study	45
II	Map showing the general soil sites under study	46
III	Characteristics of soil of experimental site is analyzed by Soil Resources Development Institute (SRDI), Khamarbari, Farmgate, Dhaka	47
IV	Monthly average of Temperature, Relative humidity, total Rainfall and sunshine hour of the experiment site during the period from January 2014 to May 2014	48
V	Analysis of variance (mean square) of plant height of mungbean at different DAS	48
VI	Analysis of variance (mean square) of plant dry weight of mungbean at different DAS	48
VII	Analysis of variance (mean square) of number of grasses per plot at different DAS	49
VIII	Analysis of variance (mean square) of number of sedge weed per plot at different DAS	49
IX	Analysis of variance (mean square) of number of broad leaf weed per plot at different DAS	49
X	Analysis of variance (mean square) of number of total weed per plot at different DAS	49
XI	Analysis of variance (mean square) of weed dry weight per square meter at different DAS	50
XII	Analysis of variance (mean square) of weed control efficiency for grass weeds	50
XIII	Analysis of variance (mean square) of weed control efficiency for sedge weeds at different DAS	50
XIV	Analysis of variance (mean square) of control efficiency for broad leaved weeds	51
XV	Analysis of variance (mean square) of weed control efficiency for total weeds at different DAS	51
XVI	Analysis of variance (mean square) of different yield contributing characters	52

LIST OF ABBREVIATIONS

AEZ	Agro-Ecological Zone
Anon.	Anonymous
AIS	Agriculture Information Service
BARC	Bangladesh Agricultural Research Council
BAU	Bangladesh Agricultural University
BBS	Bangladesh Bureau of Statistics
BINA	Bangladesh Institute of Nuclear Agriculture
BNNC	Bangladesh National Nutrition Council
BARI	Bangladesh Agriculture Research Institute
CRRI	Central Rice Research Institute
CV %	Percent Coefficient of Variance
cv.	Cultivar (s)
DAT	Days After Transplanting
DRR	Directorate of Rice Research
eds.	Editors
et al.	et alii (and others)
etc.	et cetera (and other similar things)
FAO	Food and Agricultural Organization
IARI	Indian Agricultural Research Institute
ICAR	Indian Council of Agricultural Research
IRRI	International Rice Research Institute
L.	Linnaeus
LSD	Least Significant Difference
i.e.	id est (that is)
MoP	Muriate of Potash

SAU	Sher-e-Bangla Agricultural University
SRDI	Soil Resources and Development Institute
TDM	Total Dry Matter
TSP	Triple Super Phosphate
UNDP	United Nations Development Programme
var.	Variety
<i>viz.</i>	Namely

Chapter 1

Introduction

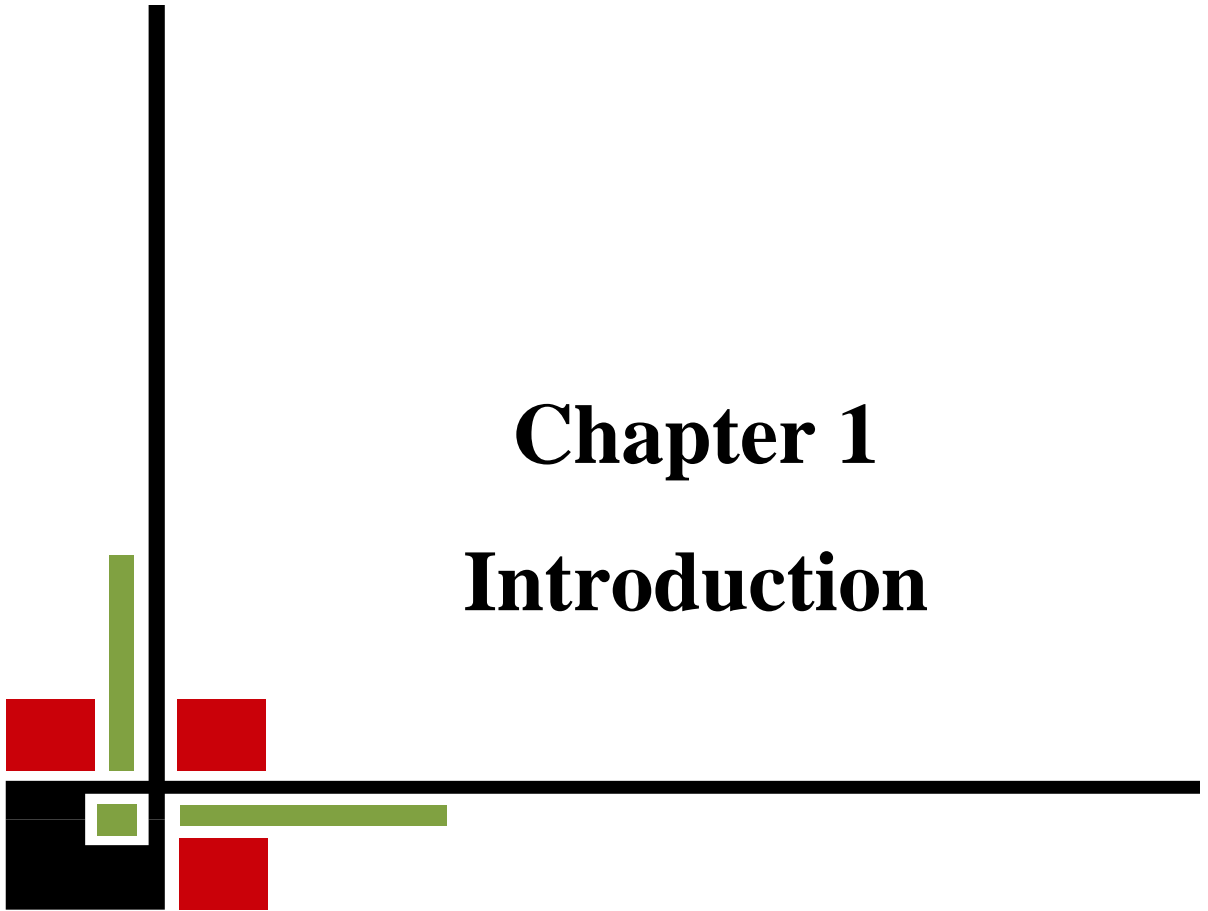

CHAPTER I

INTRODUCTION

Pulses play a vital role to meet the demand of protein human diet. Pulses are considered as poor men's meat as it is the cheapest source of protein (Mian, 1976). Bangladesh is an agro-based country where many crops like jute, sugarcane, wheat, pulses, oilseeds and vegetables are grown. Among them, pulses constitute the main source of protein for the people, especially for the poor people. Pulses also contain a good amount of vitamins and minerals. But at present, pulses are beyond the reach of the poor people in Bangladesh because of its acute shortage and thereby high price.

In Bangladesh, daily per capita consumption of pulses is only 10.96g (BBS, 2007), while the World Health Organization (WHO) recommended 45g day⁻¹ per capita for a balanced diet (BARI, 1998). So, the consumption status of pulses by our people in their daily diet is far below than the recommendation. Even to maintain the supply up to this level, the Government of Bangladesh has to spend a huge amount of foreign currency every year. In 2005-06, 1,95,000 tons of pulses were imported (BBS, 2007). The total production of pulses in Bangladesh in 2008-2009 was 5,84,000 tons from an area of 6,19,000 hectares (BBS, 2010). So to meet the suggested requirement of pulses of 45g day⁻¹ per capita, the production is to be increased even more than four folds (BBS, 2010).

Mungbean (*Vigna radiata*) is an important component in the intensive crop production system because of its short life cycle and is one of the leading pulse crops of Bangladesh. The agro-ecological condition of Bangladesh is favorable for growing this crop. It is a drought tolerant crop and can be grown with a minimum supply of plant nutrients. Cultivation of mungbean can improve the physical, chemical and a biological property of soil.

Pulses for long time have been grown with poor management practices resulting in poor yields. Proper seed bed and land preparation are important for

adequate germination of seed, crop establishment and good yields. Weeds infestation is one of the major factors lowering yield in pulses in Bangladesh. Weeds compete with main crop for space, nutrients, water and light. It is also recognized that a low weed population can be beneficial to the crop as it provides food and habitat for a range of beneficial organisms (Bueren *et al.*, 2002). One of the major constraints in mungbean production is weed competition. The loss of mungbean yield due to weed ranges from 65.4 % to 79.0 % (Shuaib, 2001). Besides causing crop losses, weeds are also responsible for reducing crop quality, nutrition status of soil etc. However, the aim of weed management should be to maintain weed population at a manageable level. Weeds above critical population thresholds can significantly reduce crop yield and quality. The weeds can be checked by adopting various. Herbicide is one of the effective methods of weed control.

However, this experiment aimed at finding an easier way to control weed in mungbean by using two herbicides.

Objectives: The objectives of experiment is as follows

1. To study the phenology and yield of mungbean.
2. To find out an efficient herbicidal weed control in mungbean cultivation.



Chapter 2

Review of Literature

CHAPTER II

REVIEW OF LITERATURE

Growth and development of mungbean are influenced by herbicidal weed control. Several experimental results related to the topic from different sources have been presented and discussed in this chapter.

2.1. Effect of herbicide on crop growth:

2.1.1 Plant height:

Different weed control methods significantly affected plant height of mungbean as reported by Chattha *et al.* (2006). The double the recommended rates of 2,4-D and isoproturon adversely affected the plant growth, photosynthetic pigments, nodulation, N content and yield of chickpea (Aamil *et al.*, 2002). Plant height at harvest varied significantly among various weed management practices in mungbean. The highest plant height was recorded in the treatment having quizalofop-p-ethyl @ 50 g a.i. ha⁻¹ at 21 DAE + HW at 28 DAE. This was similar with treatments receiving quizalofop-pethyl @ 50 g a.i. ha⁻¹ at 14 DAE + HW at 21 DAE and quizalofop-p-ethyl @ 50 g a.i. ha⁻¹ at 7 DAE + HW at 14 DAE. Among the treatments, significantly lowest height of plant was observed in weedy check plot. Crop growth rate of mungbean showed similar trend as in plant height. (Kundu *et al.*, 2009). Khaliq *et al.*, (2002) investigated the efficacy of different weed management strategies in mungbean and stated that hoeing treatments resulted in reduced weed dry weight by 79% compared to control and maximum plant height.

2.1.2. Effect on plant biomass

According to Bhanumurthy and Subramanian (1989) weed dry matter is a better parameter to measure the competition than the weed number. The percentage of reduction in weed dry weight m⁻² did not differ among Hammer (16.20%), Topstar (17.58%) and Paraxon (17.93%) but Panida performed better by reducing 34.13% dry weight over the unweeded control treatment.

Total dry matter (TDM) accumulation in mungbean increased over time as influenced by different weed management methods. (Khan. *et al.*, 2013)

2.2. Effect on Weed attributes:

2.2.1 Weed Biomass:

Maximum decrease in weed fresh 77.1% and dry weight 74.3% were recorded in plots with 35 cm row spacing with *terphali* compared to control (Hassan *et al.* ,1995; Ahmad *et al.*, 1990; Singh and Singh., 1998).

Increase in plant height and number of pods plant⁻¹ is inversely proportional to weed dry weight. (Khan *et al.*, 2008)

According to Cheema *et al.*, (2001) an inhibition of 44, 28 and 44% in total weed dry weight was noticed by three sorgaab sprays, one hand-weeding and pendimethalin treatment respectively.

A field experiment was undertaken during summer season of 2006 and 2007 under medium land situation of inceptisol at Instructional Farm, Bidhan Chandra Krishi Viswavidyalaya, Jaguli, Nadia, West Bengal to find out the effect of different weed management practices in mungbean .They found that dry weight of different categories of weeds Significantly higher dry weight of grass weeds was recorded in weedy check treatment where as dry weight of sedge and broad leaved weeds in weedy check were at par with sole herbicidal treatments (*viz.* grass, sedge and broad leaf) and total weeds differed significantly among the treatments both at 30 and 45 DAS The lowest dry weight of grass, sedge and broad leaved weeds as well as of total weeds were observed in treatment (Quizalofop-p-ethyl @ 50 g a.i. ha⁻¹ at 21 DAE + HW at 28 DAE). This was comparable with T5 treatment receiving quizalofop-p-ethyl @ 50 g a.i. ha⁻¹ at 14 DAE + HW at 21 DAE both at 30 and 45 DAS. Dry weight of total weeds followed the same trend as found in grass, sedge and

broad leaved weeds separately. Similar result was also reported by Bedmar (1997).

2.2.2 Weed Density:

In lentil, pigeonpea, cowpea, soybean, blackgram and green gram, the common weeds found are: *Trianthus*, *Convolvulus*, *Amaranthus*, *Euphorbia sp.* etc. and grassy weeds like *Cyperus*, *Cynodon*, *Echinochloa sp.* etc. Weeds compete with main crop for space, nutrients, water and light. It is also recognized that a low weed population can be beneficial to the crop as it provides food and habitat for a range of beneficial organisms (Bueren *et al.*, 2002).

Kundu *et al.*, (2009) conducted an experiment and they found. Weed population in mungbean field differed significantly with the different weed management practices both at 30 and 45 days after sowing (DAS). Quizalofop-p-ethyl @ 50 g a.i. ha⁻¹ at 21 DAE + HW at 28 DAE (T8) showed the lowest population of grass, sedge and broad leaved weeds at both the stages. This was statistically at par with the treatment (quizalofop-p-ethyl @ 50 g a.i. ha⁻¹ at 14 DAE + HW at 21 DAE). The weedy check treatment showed significantly highest population of grass weeds among all the treatments. However, sole herbicidal treatments were comparable with each other and at par with weedy check with respect to population of sedge and broad leaved weeds. The total weed population was significantly highest in weedy check treatment whereas, maximum reduction of total weed population was found in and T5 treatments both at 30 and 45 DAS.

According to Khan. *et al.*, (2011) Weeds species in number and their relative density as affected by different weed management methods at 25 and 45 DAE are presented in. It was observed that *Echinochloa crusgalli* (Shyma), *Digitaria sanguinalis* (Anguli), *Cyperus rotundus* (Mutha) and *Alternanthera*

philoxeroides. (Maloncha) were the common weeds in mungbean field. Among the weed species, *Echinochloa crusgalli*, *Digitaria sanguinalis* and *Cyperus rotundus* were the dominant weeds. Similar results were also reported by Khan *et al.*, (2011). Density of grasses and sedges were significantly influenced by glyphosate spraying and tillage techniques. The highest number of grasses (318 m⁻²) recorded from control treatment and the lowest (188 m⁻²) from where glyphosate spraying on zero tillage conditions at 7 DBS, which was statistically similar to T5 where two times tillage done with 7 days interval before sowing. But the highest number of sedges (128 m⁻²) recorded from T5, which was two times higher than control (T7) and the lowest (34 m⁻²) recorded in T1. Weed density was significantly influenced by different weed management methods. The highest weed density 414 and 704 weeds m⁻² were recorded in control plot at 25 and 45 DAE, respectively. The lowest weed density at 25 DAE recorded in T6 (68 m⁻²) which was followed by T1 (216 m⁻²). At 45 DAE the lowest weed density was also from T6 (108 m⁻²) but followed by T5 (172 m⁻²) and T4 (220 m⁻²).

2,4-Dichlorophenoxy acetic acid (2, 4-D) is recognized as synthetic Auxin, at lower concentrations it acts as plant growth regulator and at higher concentrations it act as growth retardant. It is widely used at higher concentrations as herbicide for broad leave weeds. It is known to initiate several physiological and biochemical processes which influence plant growth, development, flowering, and fruit set, fruit ripening and finally seed yield and quality (Campanoni and Nick, 2005)

2.2.3. Weed control efficiency:

An experiment was conducted at PRS, BARI, Ishurdi with five herbicides viz.: Paraxon (27.6% WV Paraquat dichloride salt), M-clor 5G (Butaclor), Topstar 40 WP (40% Oxadiargyl), Hammer 24 EC (Carfentrazone ethyl), and Panida 33 EC (Pendimethalin) with one control (no herbicide and also no weeding)

were applied in two leaf stage of mungbean as dose mentioned in treatment. Among the herbicides, Panida performed the best for reducing the number and dry weight of weeds. The maximum reduction of weed population, the highest weed control efficiency, seed yield (1222 kg ha⁻¹), and maximum economic benefit were also obtained in the treatment receiving Panida 33 EC @ 2 ml L⁻¹ (BARI, 2008)

According to Kundu *et al.*, (2009) the highest weed control efficiency was found in T8 (quizalofop-p-ethyl @ 50 g a.i. ha⁻¹ at 21 DAE + HW at 28 DAE) followed by T5 (quizalofop- ethyl @ 50 g a.i. ha⁻¹ at 14 DAE + HW at 21 DAE).

2.3. Effect on yield and yield attributing characters:

2.3.1. Number of pod per plant:

Number of pods per plant among the herbicidal treatments was statistically similar but unweeded control produced the least. Chattha *et al.* (2006) observed that the number of pods per plant was significantly affected by different weed control. It is also observed that mungbean showed significant increase in plant height and number of pods plant⁻¹ Khan *et al.* (2011).

Increase in plant height and number of pods plant⁻¹ is inversely proportional to weeds density and dry weight and similar is the case with the number of grains pod⁻¹. Production capacity of mungbean can be determined by the number of pods plant⁻¹ (Khan *et al.*, 2008). Yield attributes and seed yield Yield attributes (viz. number of pods plant⁻¹, number of seeds pod⁻¹) and seed yield of mungbean varied significantly with different weed management practices. The number of pods plant⁻¹, seeds pod⁻¹ as well as seed yield (1327 kg ha⁻¹) were highest in the treatment having quizalofop-p-ethyl @ 50 g a.i. ha⁻¹ at 21 DAE + HW at 28 DAE. This was closely followed by the treatment with quizalofop-p-ethyl @ 50 g a.i./ha at 14 DAE + HW at 21 DAE. Similar result was also

reported by Singh result was also reported by Singh et al. (2001). All dose rates of 2,4-D decreased the number of pod per plant. Zaidi *et al.* (2005).

2.3.2. Pod length:

Pod length was recorded maximum in plots where treatments were *terphali* (9.9 cm) and hand weeding (9.7 cm); while in plots with 45cm row spacing + tractor and 60cm + tractor, pod length was 9.2cm and 9.6 cm, respectively compared to control (9.0 cm). This might be due to weed suppression which resulted in more translocation and assimilation of photosynthates towards reproductive growth (Borras *et al.*, 2004)

2.3.3. 1000 seed weight :

Yield and yield contributing characters of mungbean were significantly influenced by different weed management methods except 1000-seed weight (Khan *et al.*, 2008)

In accordance with the result found by Borras *et al.*, (2004) thousand grain weight was also increased with reduction in weeds dry biomass and found to be maximum (55.0 g) in plots with row spacing 60 cm + tractor followed by 54.67 g in plots with spacing of 45 cm + tractor. Similarly, it was 51.67 g in case of hand weeding, 51.33 g in *terphali* driven plots and 50.67 g in case of control. These findings were in line with the previous research conducted by Cheema and Akther (2005) who found that 1000-grain weight increased with reduced weed infestation.

2.3.4. Yield:

A significant difference between years regarding yield and yield component of mungbean was recorded being maximal during the second year. Possibly less weed bank and less competition of mungbean crop for growth resources due to more reduction of weeds during second year may be the possible reason for this improvement of these yield and yield component. These treatments showed

about 28% and 18%, respectively more number of pods as compared to weedy check. This might be due to adequate weed control during the cropping period, which provided maximum moisture and nutrients for healthy plant growth and hence pod formation. Similar results have also been discussed by Nawaz *et al.* (1990) and Khan *et al.* (1991a & b). Rana and Pal (1997) founded that crops grown with proper weeding could produce higher yields. Similar findings have also been reported by Mathew and Sreenivasan (1998).

Chapter 3

Materials & Methods

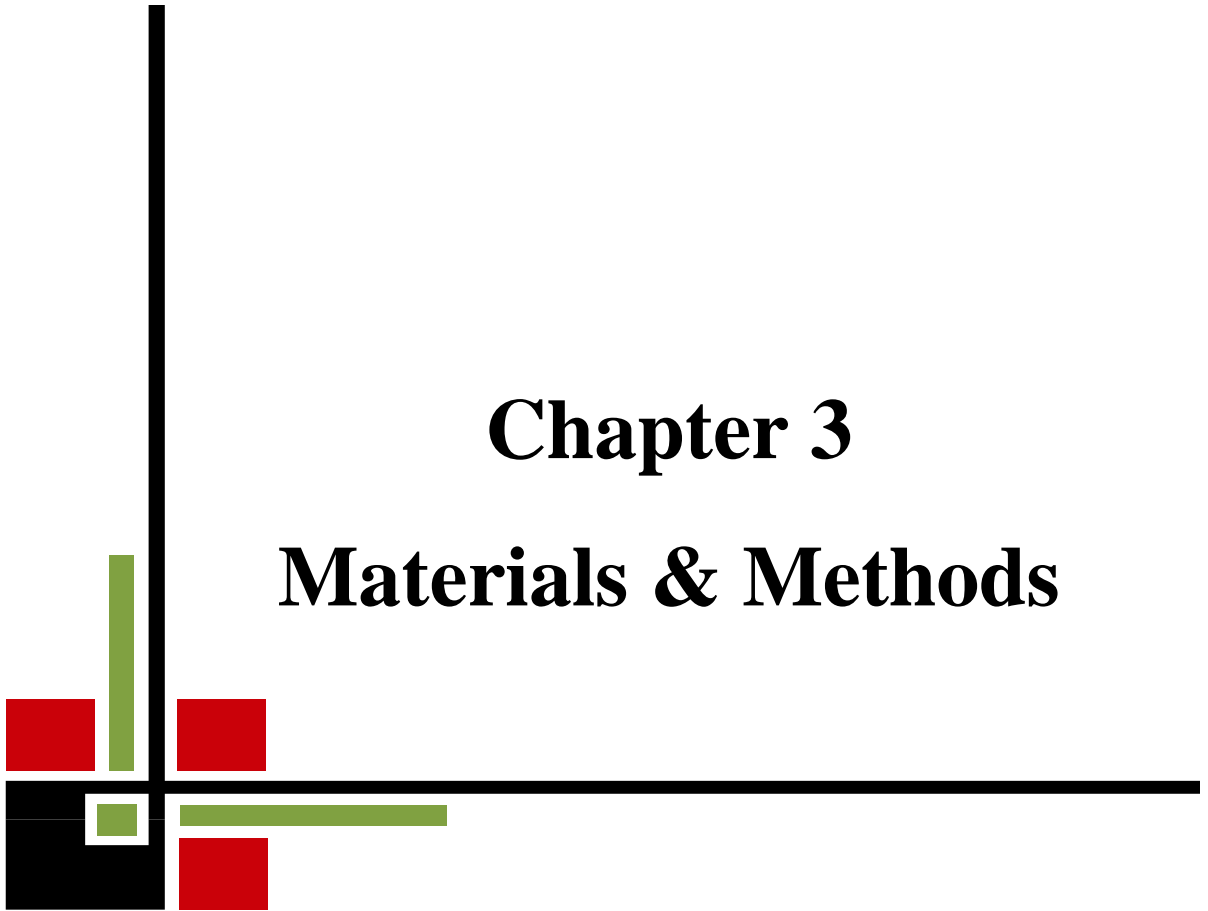

CHAPTER III

MATERIALS AND METHODS

The experiment was conducted during April to June, 2014 at Agronomy field laboratory of Sher-e-Bangla Agricultural University. The experiment was conducted to study herbicidal effect on growth and yield of mungbean. The materials and methodologies used for the experiment are discussed below.

3.1 Site description

The experiment was conducted at the Sher-e-Bangla Agricultural University research farm, Dhaka, during the period from April to June, 2014. The experimental site was located at 23°77' N latitude and 90°37' E longitudes with an altitude of 9 m.

3.2 Agro-ecological Region

The experimental site belongs to the agro-ecological zone of “Madhupur Tract”, AEZ-28 (Anon., 1988a). This was a region of complex relief and soils developed over the Madhupur clay, where floodplain sediments buried the dissected edges of the Madhupur Tract leaving small hillocks of red soils as ‘islands’ surrounded by floodplain (Anon., 1988b). For better understanding, the experimental site is shown in the AEZ Map of Bangladesh in Appendix I.

3.3 Climate and weather

The geographical location of the experimental site was under the sub-tropical climate characterized by three distinct seasons. The monsoon or rainy season extending from May to October which is associated with high temperature, high humidity and heavy rainfall; the winter continues from November to February which is associated with moderately low temperature and the pre-monsoon period or hot season exists from March to April which is associated with some rainfall and occasional gusty winds. Information regarding monthly maximum and minimum temperature, rainfall, relative humidity and sunshine

during the period of study of the experimental site was collected from Bangladesh Meteorological Department, Agargaon and is presented in Appendix IV.

3.4 Soil

The experiment was carried out in a typical rice growing soil under the Madhupur Tract. Top soil was silty clay in texture, red brown terrace soil type, olive-gray with common fine to medium distinct dark yellowish brown mottles. Soil pH was 5.6 and had organic carbon 0.45% (Appendix III B). The land was well drained with good irrigation facilities. The experimental site was a medium high land. It was above flood level and sufficient sunshine was available during the experimental period. The morphological characters of soil of the experimental plots are as follows Soil series: Tejgaon, General soil: Non-calcareous dark grey (Appendix II). The physicochemical properties of the soil are presented in Appendix III.

3.5 Crop / Planting material:

BARI Mung-6 was used as a planting material. It was collected from Bangladesh Agricultural Research Institute, Joydebpur, Gazipur. This variety is suitable for summer season. The plant height of the variety ranges from 60-70 cm. It is resistant to *Cercospora* leaf spot and yellow mosaic diseases. Its life cycle ranges from 60-65 DAS and average yield is 2000-2100 kg ha⁻¹

3.6. Chemical criteria of herbicides under study:

3.6.1. Chemical specification of Pull 5 EC :

3.6.1.1 Composition: Quizalofop-p-ethyl 5 g/l

3.6.1.2. Chemical group: Aryloxyphenoxy-propionates

3.6.1.3. Type of formulation: Emulsifiable concentrate (EC)

3.6.1.4. Mode of action: Selective and systemic herbicide of Aryloxyphenoxy-propionates group used to control grass weeds in broad leaf crops like sugar beet, oilseed rape, sunflower, potatoes, vegetables, pineapple, soybean, field beans and other agricultural crops. The product is quickly absorbed and translocated in the weeds, and up to 5 days after application, visible symptoms of poisoning are occurred. Up to 10 days after application, the weeds are completely killed.

3.6.1.5. Safety period (pre-harvest interval): 60 days, otherwise use local restrictions if suitable.

3.6.1.6. Compatibility: The product can be applied in a mixture with foliar fertilizers recommended, excepting those with alkaline reaction.

(<http://zenithcropsciences.com>

)

3.6.1.7. Controlled weeds

Scientific name	Common name
<i>Sorghum halepense</i>	Johnson grass
<i>Avena fatua</i>	Spring wild-oat
<i>Setaria glauca</i>	Yellow bristle-grass
<i>Digitaria sanguinalis</i>	Red finger-grass
<i>Apera spica-venti</i>	Loose silky-bent
<i>Poa annua</i>	Annual meadow-grass
<i>Lolium temulentum</i>	Darnel
<i>Elymus repens</i>	Couch grass
<i>Cynodon dactylon</i>	Bermuda grass
<i>Echinochloa crus-galli</i>	Cockspur
<i>Bromus arvensis</i>	Field brome
<i>Egytrigia /Agropyron/ repens</i>	Common couch-grass

(<http://zenithcropsciences.com>)

3.6.2. The herbicide 2, 4-D:

Chemically, the compound is known as 2,4-Dichlorophenoxyacetic acid and has a molecular formula – for those understand those kinds of things – of $C_8H_6Cl_2O_3$.

It was actually developed as part of the World War II war effort by British team intent on increasing crop yields by suppressing weeds. It was introduced commercially in 1946 and quickly shot to the top of the usage charts. A 1996 study by the U.S. Department of Agriculture estimated that if 2, 4-D was taken off the market, it would result in \$1.6 million in increased food and fiber costs to the consumer.

It was the first "selective" herbicide, meaning that it suppressed "dicots" (plants with two seed leaves, also known as broadleaf plants) while leaving "monocots" alone (plants with one seed leaf or thin leaves). In other words, the herbicide can be sprayed on grasses (like wheat, corn, rice and other cereal crops) – it will leave them alone while it kills broadleaf weeds. (<http://www.livinghistoryfarm.org>)

3.7 Treatments under Investigation:

T₁ = Weedy check

T₂ = Spraying of Pull 5 EC @ 550 ml /ha at 15 and 25 DAS

T₃ = Spraying of Pull 5 EC @ 600 ml /ha at 15 and 25 DAS

T₄ = Spraying of Pull 5 EC @ 650 ml /ha at 15 and 25 DAS

T₅ = Spraying of Pull 5 EC @ 700 ml /ha at 15 and 25 DAS

T₆ = Spraying of Pull 5 EC @ 750 ml /ha at 15 and 25 DAS

T₇ = Spraying 2,4-D 650 ml /ha at 15 and 25 DAS

3.8 Details of the experiment:

3.8.1 Experimental treatments:

One factor experiment was conducted to evaluate the growth and yield of mungbean as influenced by Pull 5 EC @ and 2,4-D.

3.8.2 Experimental design:

The experiment was laid out in Randomized Complete Block Design (RCBD) with three replications. The layout of the experiment was prepared for distributing the treatments level. The experimental field was divided into 3 blocks. Each block was again divided into 8 plots. The total numbers of unit plots of the experiment were 24 (8 × 3). The size of the unit plot was 3 m × 2 m (6 m²). There were 0.75 m width and 10 cm depth for drains between the

blocks. Each treatment was again separated by drainage channel of 0.5 m width and 10 cm depth. The treatments were randomly distributed to each block following the experimental design (Appendix XVIII).

3.9 Growing of crops:

3.9.1. Land preparation:

The land was irrigated before ploughing. After having field capacity, land was conditioned and firstly opened with disc plough. The first ploughing was done on 08 March, 2014 and final land ploughing was done on 10 March, 2014. The experiment field was divided and arranged according to experiment layout. The basal fertilizer dose was applied on 10 March, 2014.

3.9.2. Fertilizer Application:

Urea, Triple Super Phosphate (TSP) and Muriate of Potash (MP) were used as a source of nitrogen, phosphorus and potash. BARI (2005) recommended dose were applied. All the fertilizers were applied as a basal dose during final land preparation.

Nutrient	Source	Dose (kg ha⁻¹)
N (Nitrogen)	Urea (46% N)	30
P (phosphorus)	TSP (20% P ₂ O ₅)	48
K (potassium)	MoP (50% K ₂ O)	30

Source: BARI (2005)

3.9.3. Seed Sowing:

Seeds were sown on 10 March, 2014. The seed rate was maintained at 30 kg ha¹. Seeds were treated with fungicide provex to protect them from seed borne diseases. Seeds are placed in rows having distance of 30 cm and depth of 2-3 cm.

3.9.4. Emergences of seedling:

Seed germination occurred on 13 March, 2014 and 50% seed germination was recorded on 17 March, 2014.

3.10 Intercultural Operation:

3.10.1. Weeding and thinning:

Two thinning were done to maintain desired plant population. The first thinning was done at 8 DAS and second one was done at 15 DAS.

Spraying of herbicide Pull 5 EC @ was sprayed at different concentration on 15 and 35 DAS. There was also spraying of 2,4-D one three plot according to the treatment.

3.10.2 Irrigation and Drainage:

Two irrigations were applied first one at 10 DAS and Second at 30 DAS. During the final stage of experimentation there were few rains so drainage of water was confirmed where it required.

3.10.3 Insect control:

Malathion 57EC was sprayed @ 1.5 l ha⁻¹ at the time of 50% pod formation stage to control pod borer.

3.11 Determination of Maturity

At the time when 80% of the pods turned brown in color, the crop was assessed to attain maturity.

3.12 Harvesting and Sampling

The crops were harvested from central 1.0 m² area of each plot for yield data on different dates as they attained maturity. Five randomly selected plants from each plot were uprooted carefully for recording data on plant height, pods plant⁻¹, pod length and seed weight plant⁻¹.

3.13 Threshing

The crop bundles were sundried for two days by placing them on threshing floor. Seeds were separated from the plants by beating the bundles with bamboo sticks.

3.14 Drying, Cleaning and Weighing:

The collected seeds were dried 2 days in the sun for reducing the moisture. The dried seeds and stover were cleaned and weight of seeds plot⁻¹ was recorded.

3.15 Recording of Data

Data were recorded on the following characters

- i. Plant height (cm)
- ii. Plant dry weight (g)
- iii. Days to seedling emergence
- iv. Days to 50% seedling emergence
- v. Days to 50 % weed emergence
- vi. Days to 50% flowering
- vii. Days to harvesting
- viii. Days to harvesting
- ix. Number of grass weeds plot⁻¹
- x. Number of sedge weeds plot⁻¹

- xi. Number of Broad leaf weeds plot⁻¹
- xii. Total weeds plot⁻¹
- xiii. Weed Biomasses plot⁻¹
- xiv. Number of pod plot⁻¹
- xv. Pod length (cm)
- xvi. Shell weight m⁻² (g)
- xvii. 1000 seed weight (g)
- xviii. Yield (t/ha)

3.16 Outline of Data Recording

A brief outline of data recording procedure is given below:

i) Plant height (cm)

The height of plant was recorded in centimeter (cm) at the time of 30, 40, 50 DAS and at harvest. Data were recorded as the average of 5 plants plot⁻¹ selected at random from the outer side rows (started after 2 rows from outside) of each plot. The height of the plant was determined by measuring the distance from the soil surface to the tip of the top leaf.

ii) Plant dry weight (g)

Total dry matter weight plant⁻¹ was recorded at the time of 30, 40, 50 DAS and at harvest by drying plant samples. The plant samples were oven dried at 72 °C temperature until a constant level from which the weight of total dry matter were recorded. Data were recorded as the average of 5 sample plants plot⁻¹ selected at random from the outer rows of each plot leaving the border line and expressed in gram.

iii) Days to Seedling Emergence:

It was taken by an overview when first germination of crops took places.

iv) Days to 50% seedling Emergence:

It was observed on 14 March, 2014 when 50% seed were germinated.

v) Days to 50 % Weed germination:

It was taken by an overview to measure first germination of crops took places. It was recorded on 12 March, 2014.

vii) Days to harvesting

Days to harvesting was considered when the 80% pod of the plants within a plot becomes blackish in color. The number of days to maturity was recorded from the date of sowing.

viii) Number of grass weeds plot⁻¹:

The number of grass weed per plot was counted at 15, 25, 35 DAS.

ix) Number of sedge weeds plot⁻¹:

The number of sedge weed per plot was counted at 15, 25, 35 DAS.

x) Number of broad leaf weeds plot⁻¹:

The number of broad leaf weed per plot was counted at 15, 25, 35 DAS.

xi) Weed biomasses plot⁻¹:

Dry weight of all the weed population in a square meter from each plot was taken at 15, 25 and 35 DAS. The weed samples were oven dried at 72 °C temperature until a constant level from which the weight of total dry matter were recorded.

xii) Weed control efficiency:

The crop growth rate, weed population, weed dry weight and weed control efficiency were recorded at different stages of the crop. Weed control efficiency were obtained by using the following formula.

$$WCE = \frac{(\text{Maximum number of weed found in a plot} - \text{Number of weed in treated plot})}{\text{Maximum number of weed found in a plot}} \times 100$$

xiii) Number of pods plant⁻¹

The number of pods from 10 randomly selected plants of each plot was determined at the time of harvest to find out the number of pods plant⁻¹

xiv) Pods length (cm)

Length of 30 pods from 10 randomly selected plants of each plot was measured with the help of a centimeter scale and their average value was recorded.

xvi) Shell weight meter⁻² (g):

Shell weight per square meter was taken from each plot.

xvii) Weight of 1000-grains (g)

One thousand cleaned dried seeds were counted randomly from the total cleaned harvested grains of each individual plot and then weighed with a digital electric balance at the stage the grain retained 14% moisture and the mean weight were expressed in gram.

xviii) Grain yield (t ha⁻¹)

The grain of the whole plot, i.e. 4 m × 2.5 m = 10 m² excluding the border row was harvested, cleaned, threshed, dried and weighed. Finally, grain yield plot⁻¹ was converted and expressed in t ha⁻¹ on 14% moisture basis. Grain moisture content was measured by using a digital moisture tester. Grain weight plot⁻¹ was calculated by using following formula:

$$\text{Grain weight (final)} = \text{Initial weight} \times \frac{100 - \text{initial moisture content}}{100 - \text{final moisture content}} \text{ (tones)}$$

3.18 Statistical analysis

The data obtained for different characters were statistically analyzed following the analysis of variance techniques to obtain the level of significance by using MSTAT-C computer package program (Fred, 1986). The significant differences among the treatment means were compared by Least Significant Difference (LSD) at 5% levels of probability.

Chapter 4

Results and Discussion

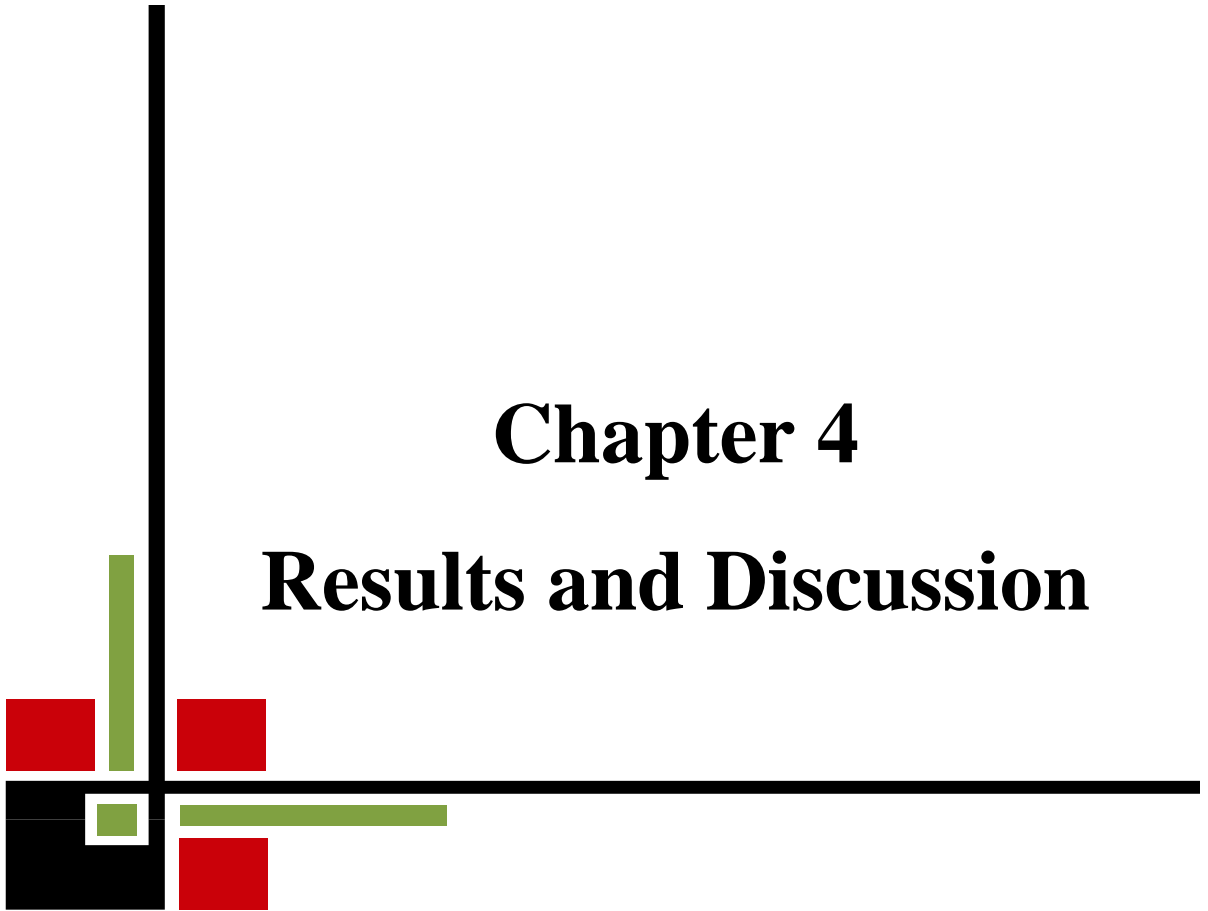

CHAPTER IV

RESULT AND DISCUSSION

The experiment was conducted to study different growth, yield and weed parameters. In this chapter we are going to discuss about these.

4.1. Effect on crop growth:

4.1.1. Plant height (cm):

The height of individual plant was observed in 10 days intervals starting from 30 DAS to harvest. At 30 DAS there is no significant difference among the treatments (Table 1). At 40 DAS there were significant differences among the treatments. The tallest plant (33.86 cm) was found with the treatment (T₃) of spraying of Pull 5 EC @ 600 ml/ ha at 15 DAS & 25 DAS and the shortest plant (20.04 cm) was found in (T₇) spraying of 2,4-D 5 EC 650 ml/ ha at 15 DAS & 25 DAS , but there was no statistically difference among other treatment except (T₇) spraying of 2,4-D 5 EC 650 ml/ ha (Table 1) . At 50 DAS different plant height were observed among the treatments, as the tallest plant (36.33 cm) was found in (T₄) spraying of Pull 5 EC @ 600 ml/ ha at 15 DAS & 25 DAS and the shortest plant (22.73 cm) was found in (T₇) spraying of 2,4-D 5 EC 650 ml/ ha at 15 DAS & 25 DAS. During harvest the plant height was taken there were significant differences among treatments (Table 1). The tallest plant (36.78 cm) was found in (T₃) spraying of Pull 5 EC @ 600 ml/ ha at 15 DAS & 25 DAS and the shortest (22.96 cm) on is observed in Spraying of 2.4-D 650 ml/ ha at 15 DAS & 25 DAS. This results indicates that spraying of herbicide Pull has influenced the plant height positively while application of 2,4-D hampered the plant growth. Plant became stunted and leaves became curled which ultimately reduced the plant growth.

4.1.2. Plant dry weight:

The dry matter of crop plant was taken at 30, 40, 50 DAS & at harvest all of those are showed in (Figure 1). At 30 DAS the highest weight (6.07 g) was found with the treatment (T₄) of spraying of Pull 650 ml/ ha at 15 DAS & 25 DAS and lowest (4.12 g) was with the treatment of (T₁) weedy check. But there were no significant differences among the treatments. At 40 DAS there were also no significant differences as far as plant dry matter accumulation is concerned. At 50 DAS the maximum plant biomass (19.38 g) was accumulated with the treatment of (T₂) spraying of Pull 5 EC @ 550 ml/ ha at 15 DAS & 25 DAS and the minimum was found with the treatment of (T₇) spraying of 2.4-D 650 ml/ ha at 15 DAS & 25 DAS. During harvest maximum dry weight per plant was taken and maximum weight were found in (T₆) spraying of Pull 5 EC @ 750 ml/ ha at 15 DAS & 25 DAS and minimum were in Spraying of 2.4-D 650 ml/ ha at 15 DAS & 25 DAS.

Table 1: Herbicidal effect on plant height (cm)

Plant Height (cm)				
Treatment	30 DAS	40 DAS	50 DAS	HARVEST
T1	18.78	28.93 ab	30.3 ab	31.01 b
T2	19.41	30.18 ab	34.62 ab	36.64 a
T3	17.12	33.86 a	33.23 ab	36.78 a
T4	17.42	31.94 a	36.33 a	36.50 a
T5	16.27	29.833 ab	32.5 ab	33.72 ab
T6	16.16	27.82 b	31.53 ab	32.03 ab
T7	14.1	20.04 c	22.73 b	22.96 c
LSD	NS	4.95	12.02	5.15
CV%	13.92	9.61	31.48	30.11

T₁ = Weedy
check

T₂ = Spraying of Pull 5 EC @ 550ml/ha at 15
and 25 DAS

T₃ = Spraying of Pull 5 EC @ 600ml/ha at 15
and 25 DAS

T₄ = Spraying of Pull 5 EC @ 650ml/ha at 15
and 25 DAS

T₅ = Spraying of Pull 5 EC @ 700ml/ha at 15
and 25 DAS

T₆ = Spraying of Pull 5 EC @ 750ml/ha at 15
and 25 DAS

T₇ = Spraying of 2,4-D @ 650 ml/ha at 15 and
25 DAS

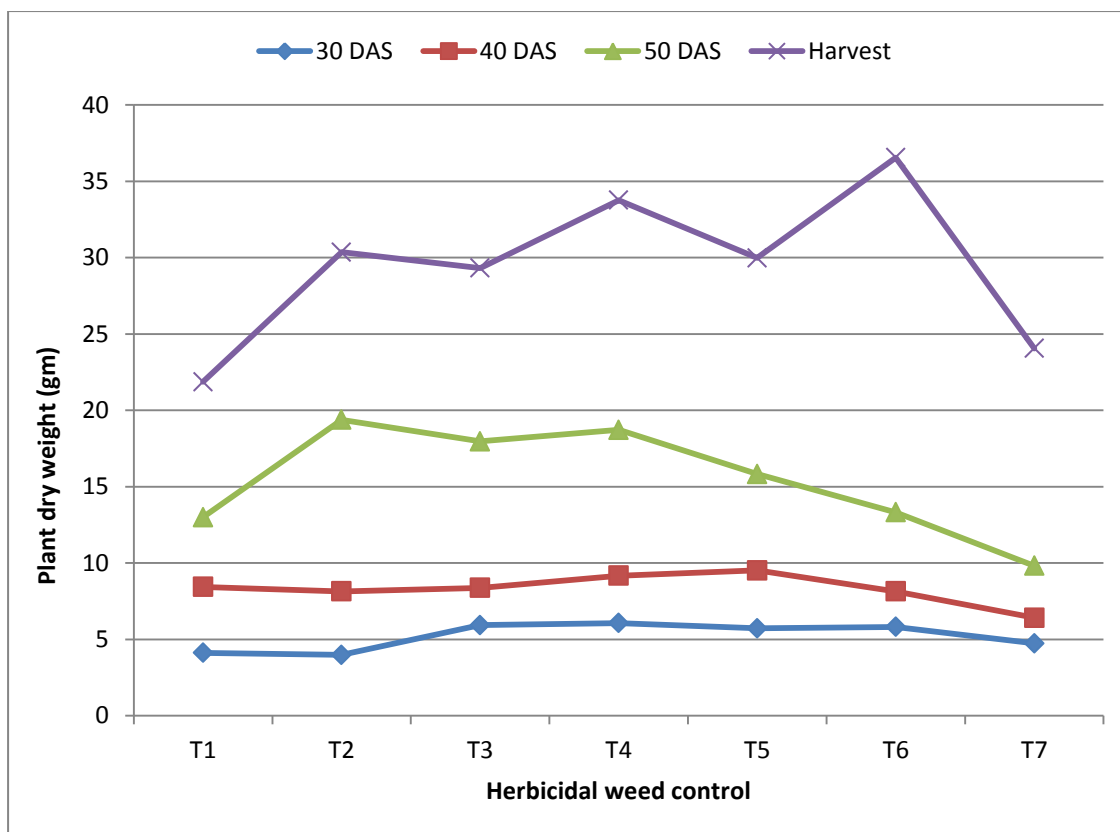

Here,

T₁ = Weedy check

T₂ = Spraying of Pull 5 EC @ 550ml/ha at 15 and 25 DAS

T₃ = Spraying of Pull 5 EC @ 600ml/ha at 15 and 25 DAS

T₄ = Spraying of Pull 5 EC @ 650ml/ha at 15 and 25 DAS

T₅ = Spraying of Pull 5 EC @ 700ml/ha at 15 and 25 DAS

T₆ = Spraying of Pull 5 EC @ 750ml/ha at 15 and 25 DAS

T₇ = Spraying of 2,4-D @ 650 ml/ha at 15 and 25 DAS

Figure 1: Herbicidal effect on plant biomass (g)

4.2. Effect on weed:

4.2.1 Number of grass weed per plot:

The number of grasses was counted in each plot at 15 DAS, 25 DAS and 35 DAS. At 15 DAS there was no significant differences found among the treatments (Figure 2). At 25 DAS the maximum (43) grasses were found in (T₁) weedy check and the minimum (1) were found in (T₆) spraying of Pull 5 EC @ 750 ml/ ha at 15 DAS & 25 DAS. At 35 DAS the maximum grass population

(57) were found in (T₁) weedy check and minimum (3) were found in (T₆) Pull 5 EC @ 750 ml/ ha at 15 DAS & 25 DAS but there were no differences among the treatments like (T₂) spraying of Pull 5 EC @ 550 ml/ ha at 15 DAS & 25 DAS, (T₃) spraying of Pull 5 EC 600 ml/ ha at 15 DAS & 25 DAS, (T₄) spraying of Pull 650 ml/ ha at 15 DAS & 25 DAS , (T₅) spraying of Pull 5 EC @ 700 ml/ ha at 15 DAS & 25 DAS with the best treatment(Figure 2).

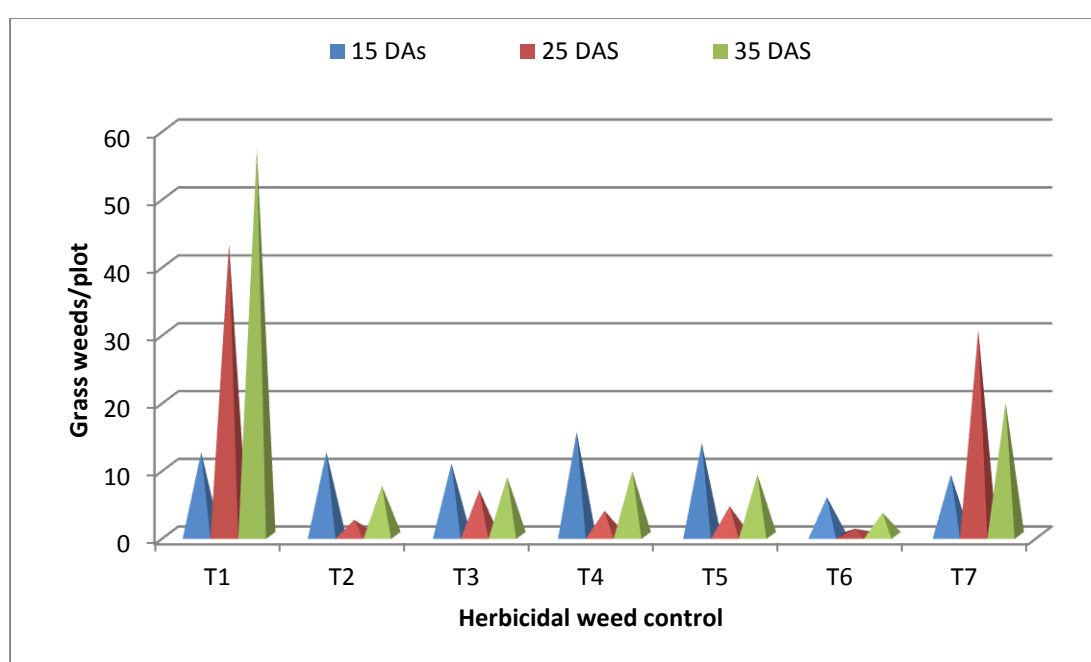

Here,

T₁= Weedy check

T₂ = Spraying of Pull 5 EC @ 550ml/ha at 15 and 25 DAS

T₃ = Spraying of Pull 5 EC @ 600ml/ha at 15 and 25 DAS

T₄ = Spraying of Pull 5 EC @ 650ml/ha at 15 and 25 DAS

T₅ = Spraying of Pull 5 EC @ 700ml/ha at 15 and 25 DAS

T₆ = Spraying of Pull 5 EC @ 750ml/ha at 15 and 25 DAS

T₇ = Spraying of 2,4-D @ 650 ml/ha at 15 and 25 DAS

Figure 2: Herbicidal effect on number of grass per plot

4.2.2. Number of sedge weed per plot:

The number of sedge weed was counted on 15 DAS, 25 DAS and 35 DAS. At 15 DAS there were no significant differences among the treatments (Figure 2). At 25 DAS Maximum sedge population (63) were found in (T₁) weedy check and minimum (2.33) in (T₃) spraying of Pull 5 EC @ 650 ml/ ha at 15 DAS & 25 DAS (Figure 3). At 35 DAS there were significant differences among the treatments. At 35 DAS the maximum sedge population (75) were found in (T₁) weedy check and minimum were found in Spraying of (T₃) spraying of Pull 5 EC @ 650 ml/ ha at 15 DAS & 25 DAS (Figure 3).

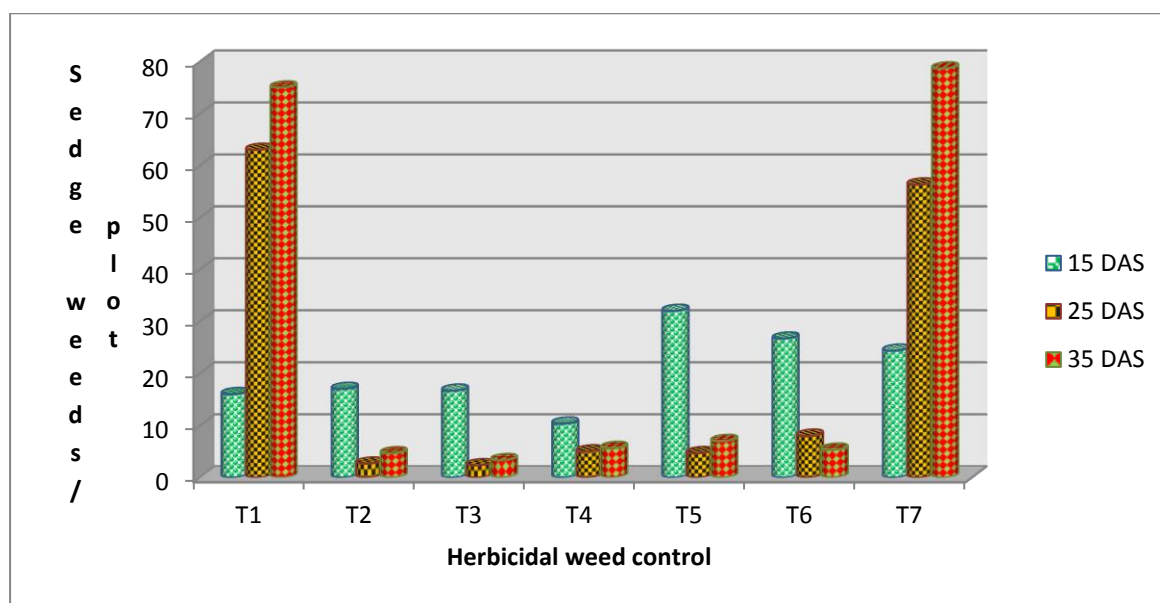

T₁= Weedy check

T₂ = Spraying of Pull 5 EC @ 550ml/ha at 15 and 25 DAS

T₃ = Spraying of Pull 5 EC @ 600ml/ha at 15 and 25 DAS

T₄ = Spraying of Pull 5 EC @ 650ml/ha at 15 and 25 DAS

T₅ = Spraying of Pull 5 EC @ 700ml/ha at 15 and 25 DAS

T₆ = Spraying of Pull 5 EC @ 750ml/ha at 15 and 25 DAS

T₇ = Spraying of 2,4-D @ 650 ml/ha at 15 and 25 DAS

Figure 3: Herbicidal effect on Number of sedge weed per plot

4.2.3. Number of broad leaf weed per plot:

The number of broad leaf weed was counted on 15 DAS, 25 DAS and 35 DAS. At 15 DAS there were no significant differences among the treatments (Figure 4). At 25 DAS there were significant differences among the treatments. The highest number of weed population was found with (T₁) weedy check and the lowest with (T₇) spraying of 2,4-D 650 ml/ ha at 15 DAS & 25 DAS. At 35 DAS the maximum weed population were observed in (T₁) weedy check and minimum in (T₇) spraying of 2,4-D 650 ml/ ha at 15 DAS & 25 DAS (Figure 4). . The result indicated that spraying of Pull 5 EC @ had non-significant effect on broad leaf weed population.

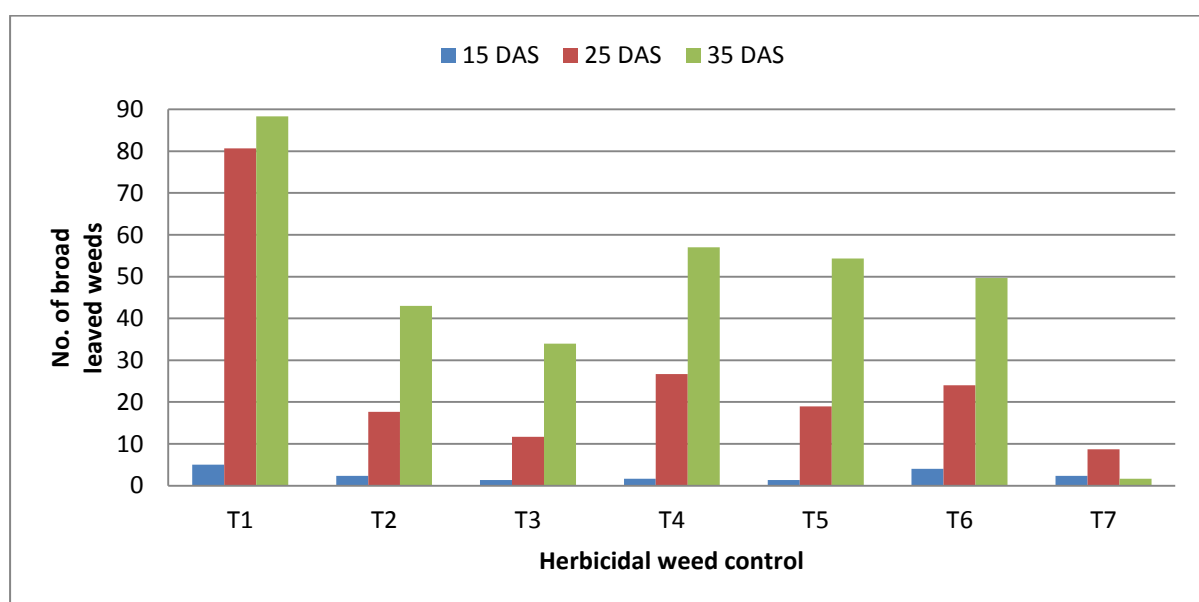

T₁= Weedy check

T₂ = Spraying of Pull 5 EC @ 550ml/ha at 15 and 25 DAS

T₃ = Spraying of Pull 5 EC @ 600ml/ha at 15 and 25 DAS

T₄ = Spraying of Pull 5 EC @ 650ml/ha at 15 and 25 DAS

T₅ = Spraying of Pull 5 EC @ 700ml/ha at 15 and 25 DAS

T₆ = Spraying of Pull 5 EC @ 750ml/ha at 15 and 25 DAS

T₇ = Spraying of 2,4-D @ 650 ml/ha at 15 and 25 DAS

Figure 4: Herbicidal effect on number of broad leaf weed per plot

4.2.4. Total weed population per plot:

The entire population weed per plot was counted on 15 DAS, 25 DAS and 35 DAS. At 15 DAS there were no significant differences among the treatments. At 25 DAS maximum weed (80) was found in (T₇) Spraying of 2.4-D 650 ml/ha at 15 DAS & 25 DAS and minimum (20) were in (T₃) spraying of Pull 5 EC @ 600 ml/ha at 15 DAS & 25 DAS (Figure 5). At 35 DAS maximum weed (177) were found in (T₁) weedy check and minimum (38) in (T₃) spraying of Pull @ 600 ml/ha at 15 DAS & 25 DAS(Figure 5).

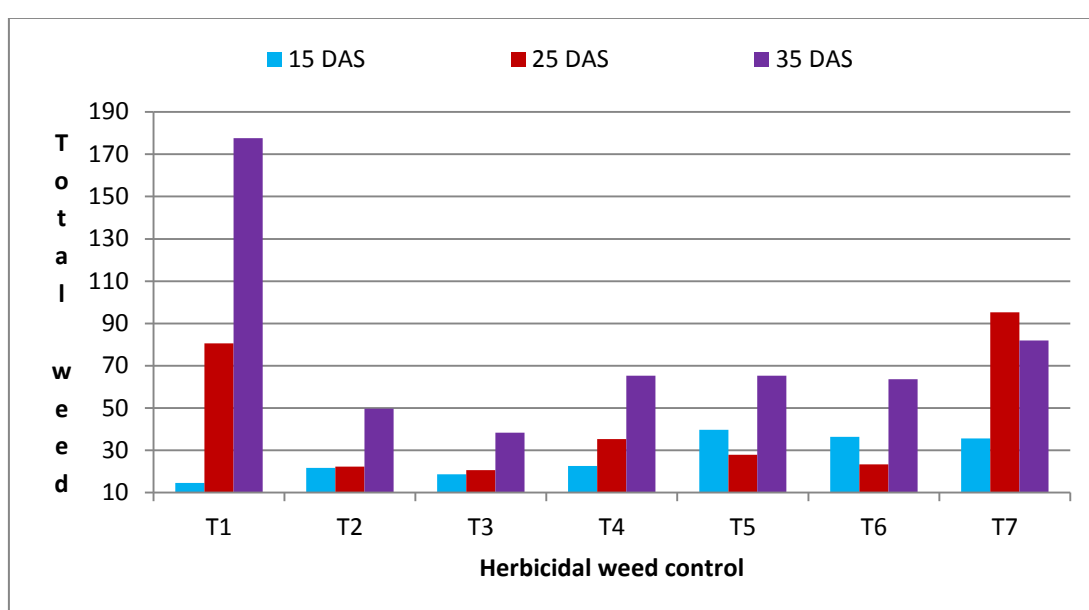

T₁ = Weedy check

T₂ = Spraying of Pull 5 EC @ 550ml/ha at 15 and 25 DAS

T₃ = Spraying of Pull 5 EC @ 600ml/ha at 15 and 25 DAS

T₄ = Spraying of Pull 5 EC @ 650ml/ha at 15 and 25 DAS

T₅ = Spraying of Pull 5 EC @ 700ml/ha at 15 and 25 DAS

T₆ = Spraying of Pull 5 EC @ 750ml/ha at 15 and 25 DAS

T₇ = Spraying of 2,4-D @ 650 ml/ha at 15 and 25 DAS

Figure 5: Herbicidal effect on total weed population

4.2.5. Weed Biomass (g) meter⁻²:

Dry weight of all the weed population in a square meter was taken at 15 DAS, 25 DAS, and 35 DAS (Figure 6). At 15 DAS (T₁) weedy check had maximum weed dry matter (82) and lowest was found in (T₄) spraying of Pull 5 EC @ 650 ml/ ha at 15 DAS & 25 DAS. At 25 DAS maximum weed dry matter accumulation was obtained at (T₇) spraying of 2.4-D 650 ml/ ha at 15 DAS & 25 DAS and minimum (31.44 g) was found in (T₄) spraying of Pull 5 EC @ 650 ml/ ha at 15 DAS & 25 DAS. At 35 DAS maximum weed dry matter accumulation (114 g) was found with spraying of 2.4-D 650 ml/ ha at 15 DAS & 25 DAS and minimum (29 g) were in (T₅) spraying of Pull 5 EC @ 700 ml/ ha at 15 DAS & 25 DAS (Figure 6).

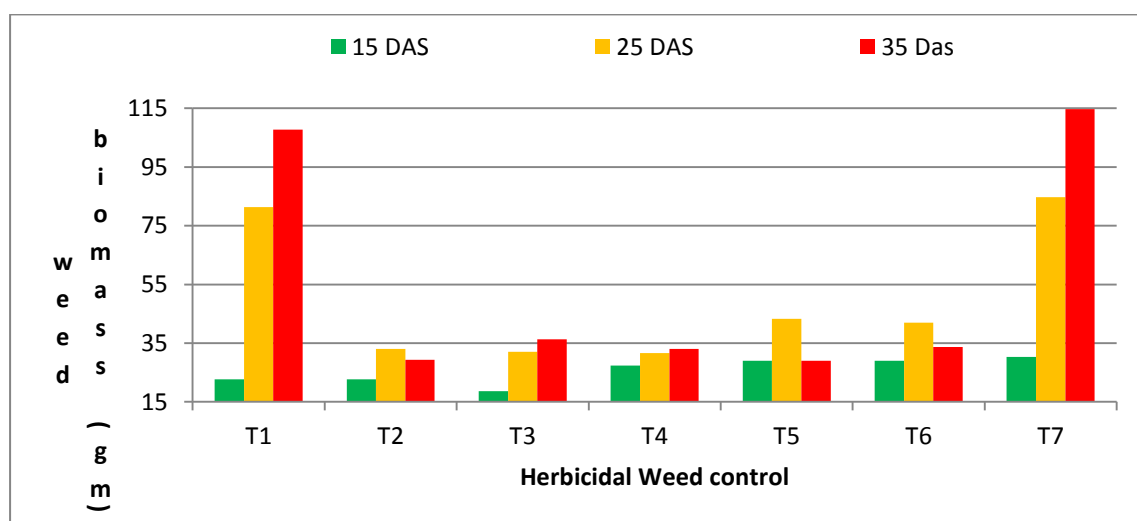

T₁= Weedy check

T₂ = Spraying of Pull 5 EC @ 550ml/ha at 15 and 25 DAS

T₃ = Spraying of Pull 5 EC @ 600ml/ha at 15 and 25 DAS

T₄ = Spraying of Pull 5 EC @ 650ml/ha at 15 and 25 DAS

T₅ = Spraying of Pull 5 EC @ 700ml/ha at 15 and 25 DAS

T₆ = Spraying of Pull 5 EC @ 750ml/ha at 15 and 25 DAS

T₇ = Spraying of 2,4-D @ 650 ml/ha at 15 and 25 DAS

Figure 6: Herbicidal effect on weed biomass

4.2.6 Weed control efficiency (WCE) :

Weed control efficiency was determined at 25 DAS AND 35 DAS.

4.2.6.1. Weed control efficiency for grasses:

At 25 DAS maximum weed reduction (97.67%) was obtained in (T₆) spraying of Pull 5EC 750 ml/ ha at 15 DAS & 25 DAS and minimum was in weedy check (Table 4). At 35 AS maximum weed control efficiency (98.53%) was found in (T₆) spraying of Pull 5EC 750 ml/ ha at 15 DAS & 25 DAS and minimum was found in weedy check (Table 4).

4.2.6.2. Weed control efficiency for sedge weed:

At 25 DAS maximum WCE was obtained in (T₃) spraying of Pull 5 EC @ 600 ml/ ha at 15 DAS & 25 DAS and minimum (96.77%) was in (T₇) spraying of 2.4-D 650 ml/ ha at 15 DAS & 25 DAS (Table 4). At 35 DAS maximum WCE (95.58%) was obtained in (T₃) spraying of Pull 5 EC @ 600 ml/ ha at 15 DAS & 25 DAS minimum was in (T₇) spraying of 2.4-D 260 ml/ ha at 15 DAS & 25 DAS (Table 4).

4.2.6.3. Weed Control efficiency for broadleaf weed:

At 25 DAS maximum weed control efficiency (89.25%) was found with (T₇) spraying of 2.4-D 650 ml/ ha at 15 DAS & 25 DAS and minimum were in weedy check (Table 4). At 35 DAS maximum weed control efficiency (97.28%) was found with (T₇) spraying of 2.4-D 650 ml/ ha at 15 DAS & 25 DAS and minimum were in weedy check. This result indicates that 2, 4-D has maximum weed control efficiency on broad leaf weed (Table 4).

4.2.6.4. Overall weed control efficiency:

As far as overall WCE is concerned at 25 DAS maximum WCE (77.77%) were found in (T₃) spraying of Pull 5 EC @ 600 ml/ ha at 15 DAS & 25 DAS and minimum in (T₇) Spraying of 2.4-D 650 ml/ ha at 15 DAS & 25 DAS. At 35 DAS maximum weed control efficiency (78.14%) were found in (T₃) spraying of Pull 5 EC @ 600 ml/ ha at 15 DAS & 25 DAS and minimum in weedy check (Table 4).

4.3. Yield attributes:

4.3.1. Number of pod per plant:

The number of pod per plant were counted .The maximum pod plant⁻¹ (108) was observed with the treatment of (T₂) spraying of Pull 5 EC 550 ml/ ha at 15 DAS & 25 DAS and the minimum were (36.66) found in(T₇) spraying of 2.4-D 650 ml/ ha at 15 DAS & 25 DAS (Table 2).

4.3.2. Average pod length (cm):

Average pod length was taken from each plot during harvest. There were no significant differences among the treatments. The tallest pod (9.60 cm) was found with the treatment of (T₆) spraying of Pull 5 EC @ 750 ml/ ha at 15 DAS & 25 DAS and shortest (9.30 cm) was with (T₇) spraying of 2.4-D 650 ml/ ha at 15 DAS & 25 DAS (Table 2).

4.3.3. Shell weight m⁻² (g):

As far as shell weight per plant was concerned there were significant differences among the treatments. The maximum shell weight (80.45 g) was found in (T₁) weedy check and the minimum (39.94 g) were in spraying of 2.4-D 650 ml/ ha at 15 DAS & 25 DAS (Table 5

Table 2: Effect of different weed control methods on yield components of mungbean

Treatment	Average pod length (cm)	No. of pod /m²	1000 seed weight (g)
T1	9.37	14.2 b	59.36
T2	9.30	21.6 a	58.09
T3	9.60	17.73 a	55.68
T4	9.30	18.33 a	58.63
T5	9.38	19.4 a	61.73
T6	9.53	18.73 a	64.48
T7	9.30	7.33 c	51.96
LSD	Ns	6.70	Ns
CV (%)	3.93	22.10	7.71

T₁= Weedy check

T₂ = Spraying of Pull 5 EC @ 550ml/ha at 15 and 25 DAS

T₃ = Spraying of Pull 5 EC @ 600ml/ha at 15 and 25 DAS

T₄ = Spraying of Pull 5 EC @ 650ml/ha at 15 and 25 DAS

T₅ = Spraying of Pull 5 EC @ 700ml/ha at 15 and 25 DAS

T₆ = Spraying of Pull 5 EC @ 750ml/ha at 15 and 25 DAS

T₇ = Spraying of 2,4-D @ 650 ml/ha at 15 and 25 DAS

4.3.4. 1000 seed weight (g):

1000 seed weight was taken from each treatment and there were no notable differences found. The maximum 1000 seed weight (64.48 g) were found with the treatment of (T₆) spraying of Pull 5 EC @ 750 ml/ ha at 15 DAS & 25 DAS and the minimum (51.96 g) were in (T₇) spraying of @2.4-D 650 ml/ ha at 15 DAS & 25 DAS (Table 5).

4.3.5. Yield (t/ha):

The grain yield was taken in tons per hectare. There were significant differences between the treatments. The maximum yield (1.64 t/ha) were found with the treatment of (T₄) spraying of Pull 650ml/ ha at 15 DAS & 25 DAS and lowest (.52 t/ha) were in (T₇) spraying of 2.4-D 650 ml/ ha at 15 DAS & 25 DAS (Table 5). The best yielded treatment i.e. (T₄) spraying of Pull 650ml/ ha at 15 DAS & 25 DAS was similar to (T₃) Spraying of Pull 5 EC @ 600ml/ha at 15 and 25 DAS, (T₄) Spraying of Pull 5 EC @ 650ml/ha at 15 and 25 DAS and (T₅) Spraying of Pull 5 EC @ 700ml/ha at 15 and 25 DAS. In case of lowest yielded treatment there was also similarity between (T₇) spraying of 2.4-D 650 ml/ ha at 15 DAS & 25 DAS and (T₁) weedy check.

Although there was no significant differences among the adobe treatments but increase in concentration of pull 5EC after @ 650 ml /ha showed decreasing trend in seed yield and spraying 2.4-D 650 ml/ ha at 15 DAS & 25 DAS had negative impact on plant phenology and yield of mungbean.

Table 3: Effect of different weed control methods on yield of mungbean

Treatment	Yield / m² (g)	Yield (ton / ha)	Shell weight/m² (g)	Shell weight (ton/ha)
T1	67.02 c	0.67 c	80.45 a	0.80 a
T2	153.60 a	1.53 a	71.52 a	0.71 a
T3	159.49 a	1.60 a	80.08 a	0.80 a
T4	164.83 a	1.64 a	59.86 ab	0.59 ab
T5	154.06 a	1.54 a	68.54 a	0.68 a
T6	133.44 b	1.33 b	77.93 a	0.77 a
T7	51.96 c	0.52 c	39.94 b	0.39 b
LSD	14.46	0.30	23.52	0.23
CV (%)	11.03	22.41	19.30	19.30

T₁= Weedy check

T₂ = Spraying of Pull 5 EC @ 550ml/ha at 15 and 25 DAS

T₃ = Spraying of Pull 5 EC @ 600ml/ha at 15 and 25 DAS

T₄ = Spraying of Pull 5 EC @ 650ml/ha at 15 and 25 DAS

T₅ = Spraying of Pull 5 EC @ 700ml/ha at 15 and 25 DAS

T₆ = Spraying of Pull 5 EC @ 750ml/ha at 15 and 25 DAS

T₇ = Spraying of 2,4-D @ 650 ml/ha at 15 and 25 DAS

Table 4: Weed control efficiency (WCE) of different weed control methods at different days after sowing

Treatment	WCE for grass (%)		WCE for sedge (%)		WCE for broad leaf (%)		WCE for total weed (%)	
	25 DAS	35 DAS	25 DAS	35 DAS	25 DAS	35 DAS	25 DAS	35 DAS
T1	0.00 g	0.00 f	0.00 e	0.00 f	0.00 f	0.00 f	0.00 f	0.00 f
T2	93.01 b	95.32 d	95.58 ab	94.35 bc	78.0 c	51.01 c	76.19 b	72.02 b
T3	83.75 e	97.15 b	96.77 a	95.58 a	85.17 b	61.17 b	77.77 a	78.14 a
T4	91.08 c	96.44 c	92.98 c	92.89 c	66.64 e	35.48 f	62.25 d	62.58 d
T5	89.96 d	98.53 a	94.19 bc	91.36 d	77.14 c	38.16 e	70.87 c	63.76 cd
T6	97.67 a	98.51 a	92.43 c	93.33 bc	70.41 d	44.59 d	75.84 b	64.72 c
T7	29.46 f	13 e	10.58 d	4.55 e	89.25 a	97.28 a	15.79 e	53.62 e
LSD	0.69	0.6	1.65	1.15	2.16	1.29	1.02	1.36
CV%	1.16	0.95	2.67	0.62	1.81	1.55	1.08	1.37

T₁ = Weedy check

T₂ = Spraying of Pull 5 EC @ 550ml/ha at 15 and 25 DAS

T₃ = Spraying of Pull 5 EC @ 600ml/ha at 15 and 25 DAS

T₄ = Spraying of Pull 5 EC @ 650ml/ha at 15 and 25 DAS

T₅ = Spraying of Pull 5 EC @ 700ml/ha at 15 and 25 DAS

T₆ = Spraying of Pull 5 EC @ 750ml/ha at 15 and 25 DAS

T₇ = Spraying of 2,4-D @ 650 ml/ha at 15 and 25 DAS



Chapter 5

Summary and Conclusion

CHAPTER V

SUMMARY AND CONCLUSION

The field experiment was conducted at the Agronomy field of central research farm of Sher-e-Bangla Agricultural University, Dhaka, during the period from April 2014 to June 2014 to study efficacy of herbicide Pull 5 EC and 2,4-D on phenology and yield of BARI mungbean 6.

This experiment consisted with (07) seven treatment viz. T₁ = Weedy check, T₂ = Spraying of Pull 5 EC @ 550 ml /ha 15 and 25 DAS, T₃ = Spraying of Pull 5 EC @ 600 ml /ha 15 and 25 DAS, T₄ = Spraying of Pull 5 EC @ 650 ml /ha 15 and 25 DAS, T₅ = Spraying of Pull 5 EC @ 700 ml /ha 15 and 25 DAS, T₆ = Spraying of Pull 5 EC @ 750 ml /ha 15 and 25 DAS, T₇ = Spraying 2,4-D 650 ml /ha 15 and 25 DAS.

The experiment was laid out in a Randomized Complete Block Design (RCBD) with three replications.

Significant variation was recorded for data on growth, yield and yield contributing parameters of experimental materials grain and straw yields were recorded after harvest of whole plot. The analysis was performed using the MSTAT-C (Version 2.10) computer package program developed by Russell (1986). The mean differences among the treatments were compared by least significant difference test (LSD) at 5 % level of significance.

The data showed that at 30 DAS there is no significant difference among the treatments. At 40 DAS there were significant differences among the treatments. The tallest plant (33.86 cm) was found with the treatment (T₃) of spraying of Pull 5 EC @ 600 ml/ ha at 15 DAS & 25 DAS and the shortest plant (20.04 cm) was found in (T₇) spraying of 2,4-D 5 EC 650 ml/ ha at 15 DAS & 25 DAS. At 50 DAS different plant height were observed among the treatments, as the tallest plant (36.33 cm) was found in (T₄) spraying of Pull 5 EC @ 600 ml/ ha at 15 DAS & 25 DAS and the shortest plant (22.73 cm) was found in

(T₇) spraying of 2,4-D 5 EC 650 ml/ ha at 15 DAS & 25 DAS. During harvest the tallest plant was found in (T₃) spraying of Pull 5 EC @ 600 ml/ ha at 15 DAS & 25 DAS and the shortest (22.96 cm) on is observed in (T₇) spraying of 2,4-D 650 ml/ ha at 15 DAS & 25 DAS. This results indicates that spraying of herbicide Pull has influenced the plant height positively while application of 2,4-D hampered the plant growth. Plant became stunted and leaves became curled which ultimately reduced the plant growth.

During harvest maximum dry weight per plant was taken and maximum weight was found in (T₆) spraying of Pull 5 EC @ 750 ml/ ha at 15 DAS & 25 DAS and minimum was in Spraying of 2,4-D 650 ml/ ha at 15 DAS & 25 DAS.

At 25 DAS the maximum (43) grasses were found in (T₁) weedy check and the minimum (1) were found in (T₆) spraying of Pull 5 EC @ 750 ml/ ha at 15 DAS & 25 DAS. At 35 DAS the maximum grass population (57) were found in (T₁) weedy check and minimum (3) were found in (T₆) Pull 5 EC @ 750 ml/ ha at 15 DAS & 25 DAS. At 35 DAS the maximum grass population (57) were found in (T₁) weedy check and minimum (3) were found in (T₆) Pull 5 EC @ 750 ml/ ha at 15 DAS & 25 DAS

At 25 DAS Maximum sedge population (63) were found in (T₁) weedy check and minimum (2.33) in (T₃) spraying of Pull 5 EC @ 650 ml/ ha at 15 DAS & 25 DAS At 35 DAS the maximum sedge population (75) were found in (T₁) weedy check and minimum were found in Spraying of (T₃) spraying of Pull 5 EC @ 650 ml/ ha at 15 DAS & 25 DAS.

At 25 DAS there were significant differences among the treatments. The highest number of weed population was found with (T₁) weedy check and the lowest with (T₇) spraying of 2,4-D 650 ml/ ha at 15 DAS & 25 DAS. At 35 DAS the maximum weed population were observed in (T₁) weedy check and minimum in (T₇) spraying of 2,4-D 650 ml/ ha at 15 DAS & 25 DAS.

At 25 DAS maximum weed (80) was found in (T₇) Spraying of 2.4-D 650 ml/ ha at 15 DAS & 25 DAS and minimum (20) were in (T₃) spraying of Pull 5 EC @ 600 ml/ ha at 15 DAS & 25 DAS (Figure 5). At 35 DAS maximum weed (177) was found in (T₁) weedy check and minimum (38) in (T₃) spraying of Pull 5EC 600 ml/ ha at 15 DAS & 25 DAS.

The result indicated that at 15 DAS (T₁) weedy check had maximum weed dry matter (82) and lowest was found in (T₄) spraying of Pull 5 EC @ 650 ml/ ha at 15 DAS & 25 DAS. At 25 DAS maximum weed dry matter accumulation was obtained at (T₇) spraying of 2.4-D 650 ml/ ha at 15 DAS & 25 DAS and minimum (31.44 g) was found in (T₄) spraying of Pull 5 EC @ 650 ml/ ha at 15 DAS & 25 DAS. At 35 DAS maximum weed dry matter accumulation (114 g) was found with spraying of 2.4-D 650 ml/ ha at 15 DAS & 25 DAS and minimum (29 g) were in (T₅) spraying of Pull 5 EC @ 700 ml/ ha at 15 DAS & 25 DAS.

Record of weed control efficiency showed that at 25 DAS maximum weed reduction (97.67%) was obtained in (T₆) spraying of Pull 5EC 750 ml/ ha at 15 DAS & 25 DAS and minimum was in weedy check (Table 4). At 35 DAS maximum weed control efficiency (98.51%) was found in (T₆) spraying of Pull 5EC 750 ml/ ha at 15 DAS & 25 DAS and minimum was found in weedy check. At 25 DAS maximum WCE was obtained in (T₃) spraying of Pull 5 EC @ 600 ml/ ha at 15 DAS & 25 DAS and minimum (96.77%) was in (T₇) spraying of 2.4-D 650 ml/ ha at 15 DAS & 25 DAS (Table 4). At 35 DAS maximum WCE (95.58%) was obtained in (T₃) spraying of Pull 5 EC @ 600 ml/ ha at 15 DAS & 25 DAS minimum was in (T₇) spraying of 2.4-D 260 ml/ ha at 15 DAS & 25 DAS. At 25 DAS maximum weed control efficiency (89.25%) was found with (T₇) spraying of 2.4-D 650 ml/ ha at 15 DAS & 25 DAS and minimum were in weedy check (Table 4). At 35 DAS maximum weed control efficiency (97.28%) was found with (T₇) spraying of 2.4-D 650

ml/ ha at 15 DAS & 25 DAS and minimum were in weedy check. This result indicates that 2, 4-D had maximum weed control efficiency on broad leaf weed.

As far as overall WCE is concerned at 25 DAS maximum WCE (77.77%) was found in (T₃) spraying of Pull 5 EC @ 600 ml/ ha at 15 DAS & 25 DAS and minimum in (T₇) Spraying of 2.4-D 650 ml/ ha at 15 DAS & 25 DAS. At 35 DAS maximum weed control efficiency (78.14%) was found in (T₃) spraying of Pull 5 EC @ 600 ml/ ha at 15 DAS & 25 DAS and minimum in weedy check.

While yield and yield contributing characters was taken under consideration it was found that the maximum pod plant⁻¹ (108) was observed with the treatment of (T₂) spraying of Pull 5 EC 550 ml/ ha at 15 DAS & 25 DAS and the minimum was (36.66) found in(T₇) spraying of 2.4-D 650 ml/ ha at 15 DAS & 25 DAS. The tallest pod (9.60 cm) was found with the treatment of (T₆) spraying of Pull 5 EC @ 750 ml/ ha at 15 DAS & 25 DAS and shortest (9.30 cm) was with (T₇) spraying of 2.4-D 650 ml/ ha at 15 DAS & 25 DAS. The maximum shell weight (80.45 g) were found in (T₁) weedy check and the minimum (39.94 g) were in spraying of 2.4-D 650 ml/ ha at 15 DAS & 25 DAS. The maximum 1000 seed weight (64.48 g) were found with the treatment of (T₆) spraying of Pull 5 EC @ 750 ml/ ha at 15 DAS & 25 DAS and the minimum (51.96 g) were in (T₇) spraying of @2.4-D 650 ml/ ha at 15 DAS & 25 DAS. The maximum yield (1.64 t/ha) was found with the treatment of (T₄) spraying of Pull 650ml/ ha at 15 DAS & 25 DAS and lowest (.52 t/ha) was in (T₇) spraying of 2.4-D 650 ml/ ha at 15 DAS & 25 DAS.

Conclusion

According to this experiment it can be concluded that:

1. Spraying of Pull (Quizalofop-p-ehyl) 5EC @ 650 ml/ha at 15 and 25 DAS was the best treatment .
2. Although spraying of 2,4-D @ 650 ml/ha at 15 and 25 DAS had controlled broad leaved weeds but it had also negative impact on the mungbean plant phenology and yield . Further investigation can be done with lower concentration of 2,4-D.
3. For wide this experiment can be repeated on different agro-ecological zones.

References

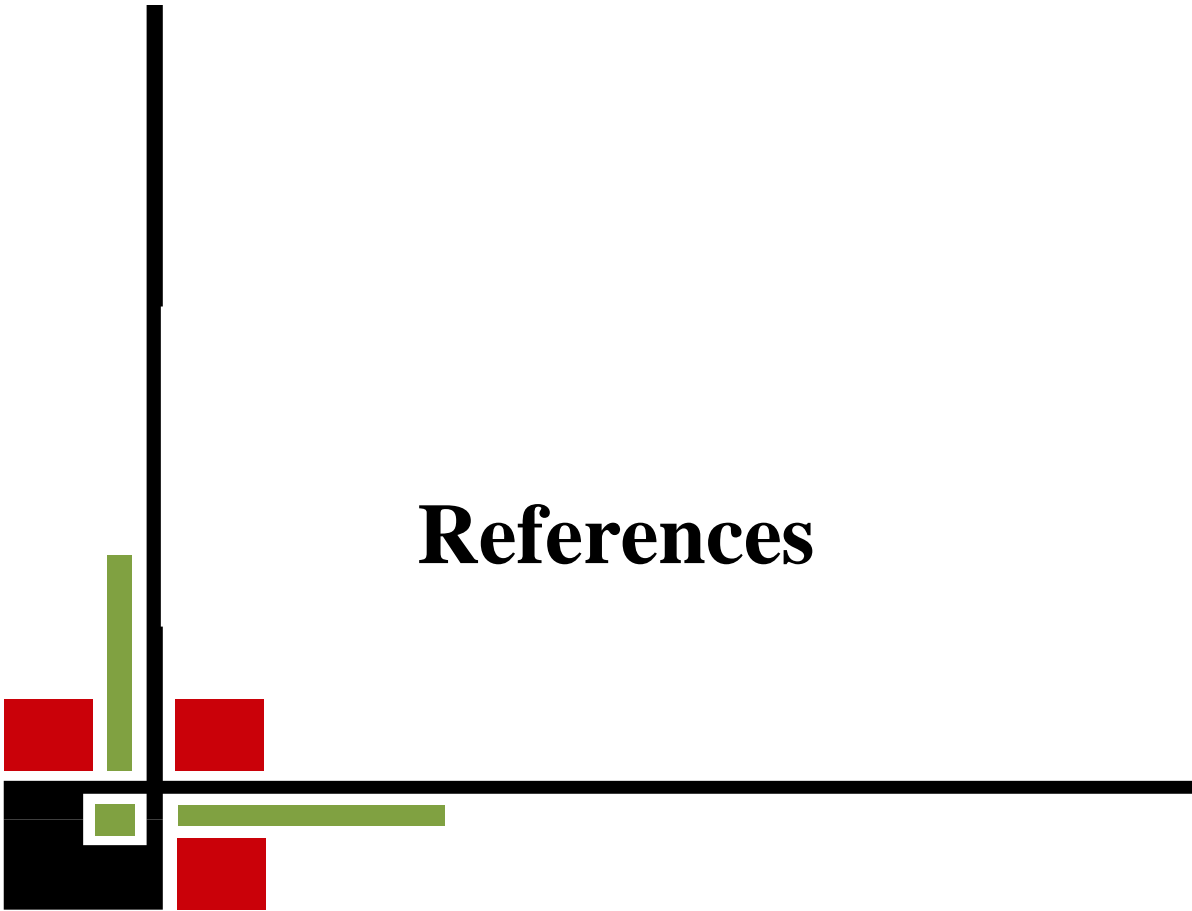

REFERENCES

- Aamil, M., Zaidi, A. and Khan, M.S. (2002). Effects of herbicide dose rates on growth, nodulation and yield in chickpea (*Cicer arietinum* L.). *Ann. Appl. Biol.* (Suppl. TAC). **23**: 8–9.
- Almas Zaidi, Khan, M.S. and Rizvi, P.Q. (2005). Effect of herbicides on growth, nodulation and nitrogen content of green gram. *Agronomy for Sustainable Development*, SpringerVerlag/EDP Sciences/INRA, 25 (4): 497–504.
- Anonymous. (1988 b). Land resources appraisal of Bangladesh for agricultural development. Report No. 2. Agro-ecological regions of Bangladesh, UNDP and FAO. pp. 472–496.
- BARI (Bangladesh Agricultural Research Institute). (1998). Mungbean cultivation in Bangladesh. A booklet in Bengali. BARI, Joydebpur, Gazipur. Publication No. 5.
- BBS (Bangladesh Bureau of Statistics). (2010). Statistical Yearbook of Bangladesh. BBS, Stat. Div., Min. Plan., Govt. People's Repub. Bangladesh, Dhaka. p. 54.
- BBS (Bangladesh Bureau of Statistics). (2007). Statistical Yearbook of Bangladesh. BBS, Stat. Div., Min. Plan., Govt. People's Repub. Bangladesh, Dhaka. p. 159.
- Bhanumurthy, V.B. and Subramanian, N.S. (1989). Adaptation of new parameters, grain yield competition for weed control study. *Indian J. Agril. Sci.* 59: 800–801.
- Borras, L., Slafer, G.A. and Otegui, M.E. (2004). Seed dry weight response to source-sink manipulations in wheat, maize and soybean: a quantitative reappraisal. *Field Crop Res.* 86: 131–146.

- Bueren, E.T.L., Struik, P.C. and Jacobsen, E. (2002). Ecological concepts in organic farming and their consequences for an organic crop ideotype. *J. Life Sci.* 40: 195–200.
- Campanoni, P. and Nick, P. (2005). Auxin dependent cell division and cell elongation. 1-Naphthalene acetic acid and 2,4-dichlorophenoxyacetic acid activate different pathways. *Plant Physiol.* 137: 939–948.
- Chattha, M.R., Jamil, M. and Mahmood, T.Z. (2006). Yield and yield components of mungbean as affected by various weed control methods under rain-fed conditions of Pakistan. *Intl. J. Agril. Biol.* 09 (1): 114–119.
- Cheema, M.S. and Akther. (2005). Efficacy of different post-emergence herbicides and their application methods in controlling weeds in wheat. *Pak. J. Weed Sci. Res.* 11: 23–30.
- Cheema, Z.A., Khaliq, A. and Akhtar, S. (2001). Use of sorgaab (sorghum water extract) as a natural weed inhibitor in spring mungbean. *Intl. J. Agric. Biol.* 3: 515–518.
- Hassan, G., Khan, N. and Khan, H. (2003). Effect of zero tillage and herbicides on the weed density and yield of chickpea under rice based conditions of D.I. Khan. *Pak. J. Weed Sci. Res.* 9: 193–200.
- Hassan, G., Nawaz, Q. and Khan, N.U. (1995). Weed management in gram through pre-emergence herbicides. Annual Report, ARI, D. I. Khan, 1994–1995.
- Khaliq, A., Aslam, Z. and Cheema, Z.A. (2002). Efficacy of different weed management strategies in mungbean (*Vigna radiata* L.). *Intl. J. Agric. Biol.* 4: 237–239.

- Khan, F.S., Zammurad, I.A., Muhammad, A. and Hussain, S. (2008). Response of mungbean genotypes to rhizobium inoculum and varying levels of nitrogen fertilizer. *Pak. J. Agric. Res.* **21**: 1–4.
- Khan, M.A., Haq, N. and Syed, A.Q. (1991 b). The effect of pre- and post-emergence herbicides on weed control and grain yield of maize. *Pakistan J. Weed Sci. Res.* **4**: 118–124.
- Khan, M.S.A., Rahman, M.T., Begum, S., Kakon S.S. and Ahmed, F. (2013). Effect of different weed management methods on growth and yield of mungbean. *Bangladesh J. Weed Sci.* **4 & 5**: 7–12.
- Kundu, R., Bera, P.S. and Brahmachari, K. (2009). Effect of different weed management practices in summer mungbean (*Vigna radiata* L.) under new alluvial zone of West Bengal. *J. Crop and Weed.* **5(2)**: 117–121.
- Nawaz, M.S., Rehman, A., Smith, F.W. and Walls, S.B. (1990). Fluazifop-butyl time and rate of application on groundnuts in Pakistan. *Pakistan J. Weed Sci. Res.* **3**: 83–88.
- Rana, K.S. and Pal, M. (1997). Productivity and water use in pigeon pea (*Cajanus cajan*) based intercropping systems as affected by weed control in rain-fed conditions. *Ind. J. Agron.* **42**: 576–580.
- Shuaib, O.S.B. (2001). Critical period for weed completion in gram. *Univ. Aden. J. Natural App. Sci.* **5** :11–18.
- Singh, G., Khajuria, V., Gill, R. and Lal, S.B. (2001). Effect of weed management practices in summer mung (*Vigna radiata*). Biennial Conf. Indian Soc. Weed Sci. March 12–14, pp. 22–23.

Web references:

<http://zenithcropsciences.com/products/quizalofop-p-ethyl-50-gl-ec/>

http://www.livinghistoryfarm.org/farminginthe70s/pests_04.html

Appendices

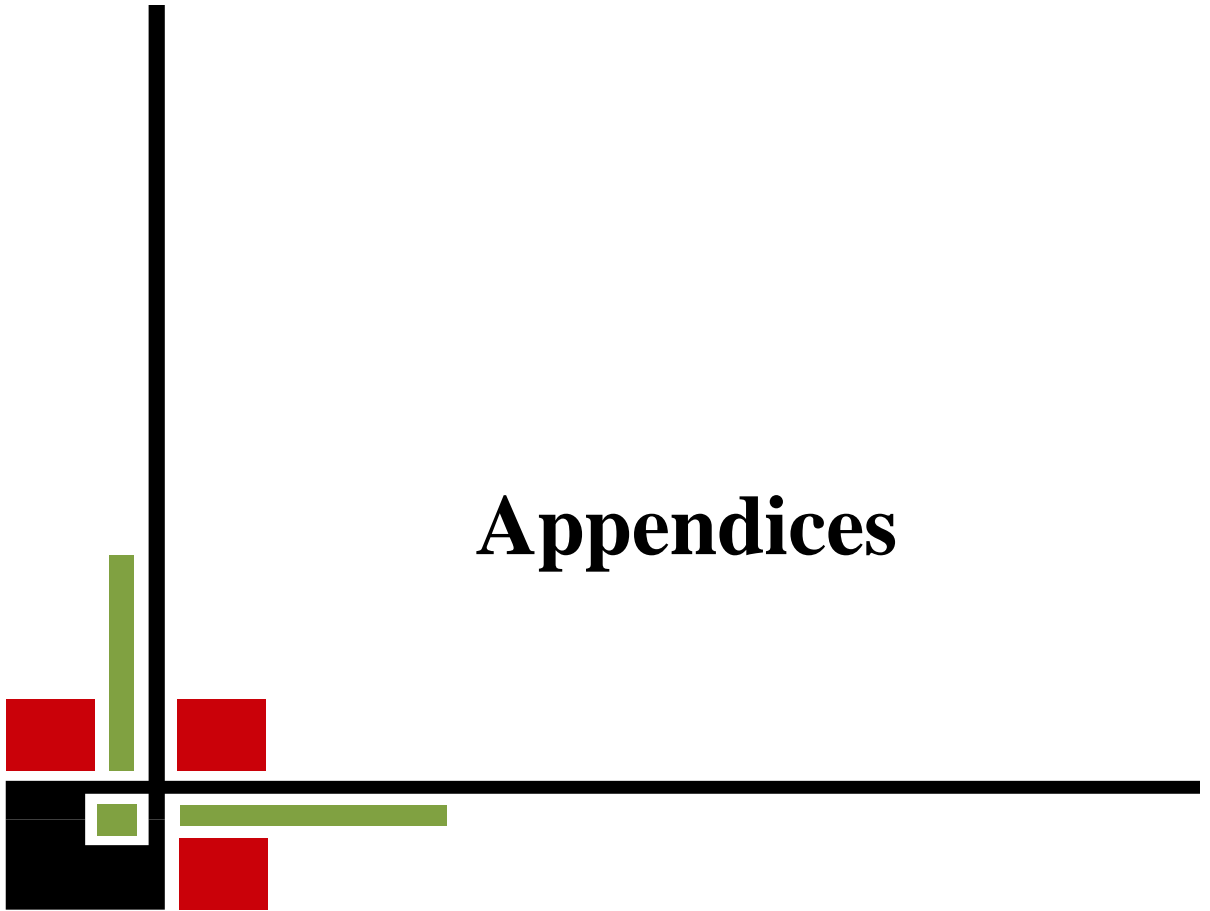

APPENDICES

Appendix I: Map showing the experimental sites under study

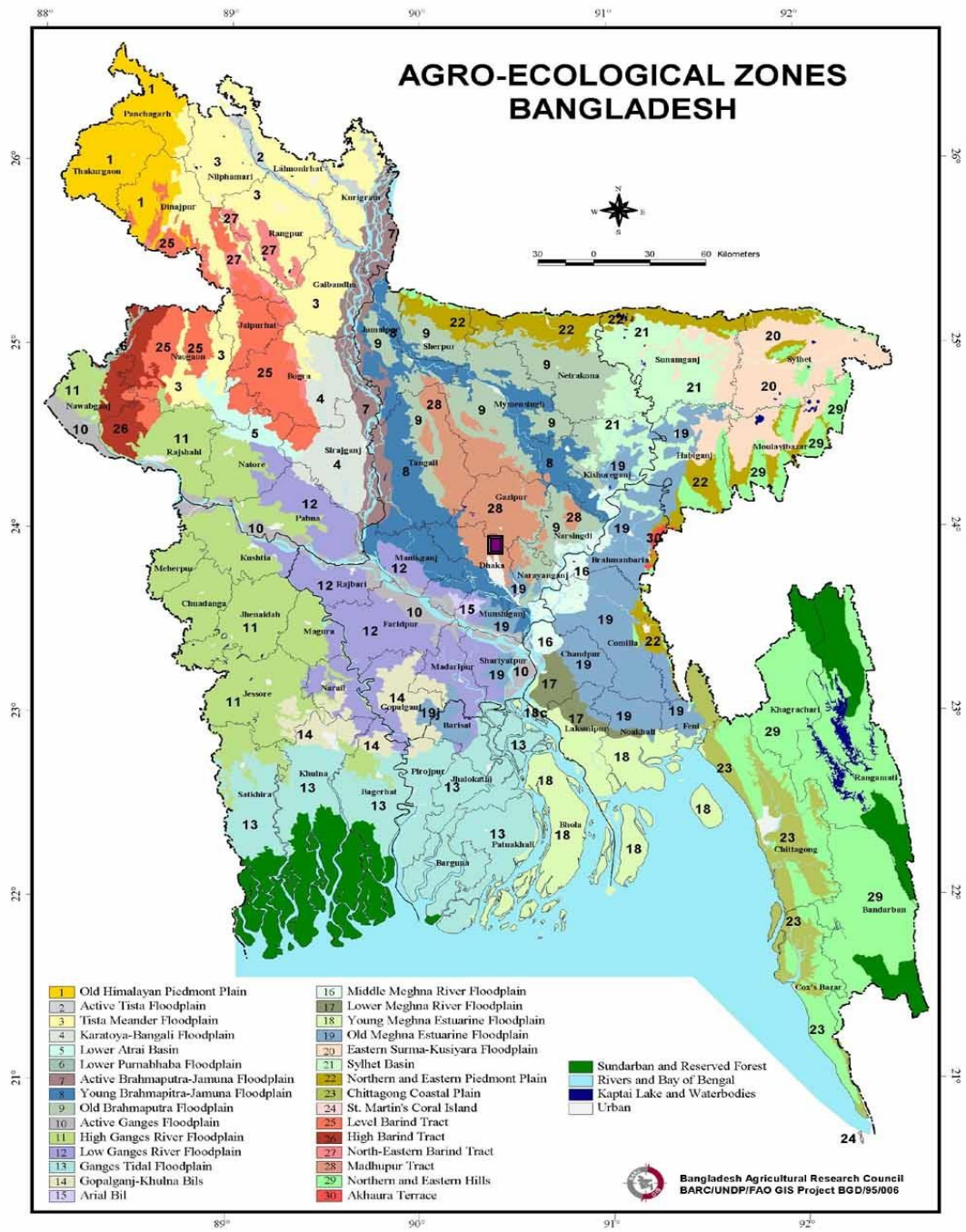

■ The experimental site under study

Appendix II: Map showing the general soil sites under study

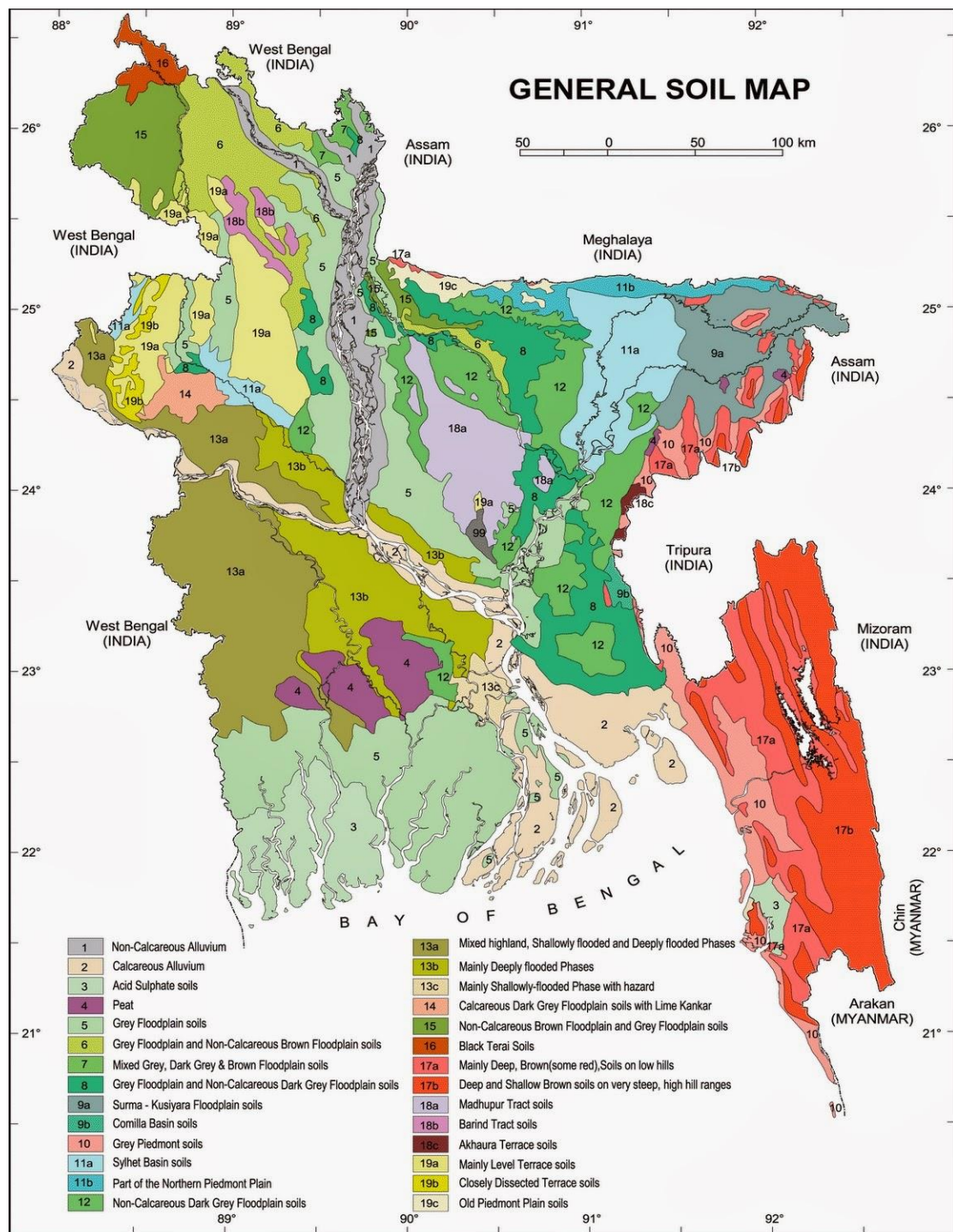

Appendix III: Characteristics of soil of experimental site is analyzed by Soil Resources Development Institute (SRDI), Khamarbari, Farmgate, Dhaka

A. Morphological characteristics of the experimental field

Morphological features	Characteristics
Location	Experimental field, SAU, Dhaka
AEZ	Madhupur Tract (28)
General Soil Type	Shallow red brown terrace soil
Land type	High land
Soil series	Tejgaon
Topography	Fairly leveled
Flood level	Above flood level
Drainage	Well drained
Cropping Pattern	Cotton–Mungbean –Fellow

B. Physical and chemical properties of the initial soil

Characteristics	Value
%Sand	27
%Silt	43
%clay	30
Textural class	Silty-clay
pH	5.6
Organic carbon (%)	0.45
Organic matter (%)	0.78
Total N (%)	0.077
Available P (ppm)	20.00
Exchangeable K (mel 1.00 g soil)	0.10
Available S (ppm)	45

Source: SRDI, 2014

Appendix IV: Monthly average of Temperature, Relative humidity, total Rainfall and sunshine hour of the experiment site during the period from January 2014 to May 2014

Year	Month	Air temperature (°C)			Relative humidity (%)	Rainfall (mm)	Sunshine (hr)
		Maximum	Minimum	Mean			
2014	January	24.73	14.31	19.52	60.52	46	166.26
	February	28.59	17.16	22.88	50.96	3	205.05
	March	32.82	22.11	27.47	48.19	53	222.58
	April	33.45	23.63	28.54	61.87	106.2	241.4
	May	35.18	26.39	30.78	64.77	138.2	219.48

Source: Bangladesh Meteorological Department (Climate division), Agargaon, Dhaka-1212.

Appendix V : Analysis of variance (mean square) of plant height of mungbean at different DAS

Sources of variation	Degrees of freedom	Mean Square			
		30 DAS	40 DAS	50 DAS	At harvest
Treatment	6	9.272	57.94*	49.2	71.82*
Replication	2	1.702	17.7	1.27*	37.16*
Error	12	5.471	7.748	8.277	8.3834

* indicates significant at 5% level of probability

** indicates significant at 1% level of probability

Appendix VI : Analysis of variance (mean square) of plant dry weight of mungbean at different DAS

Sources of variation	Degrees of freedom	Mean Square			
		30 DAS	40 DAS	50 DAS	At harvest
Treatment	6	1.97	2.92	37.42*	90.62
Replication	2	3.23	2.25	14.69	40.66
Error	12	2.28	4.89	6.09	26.36

* indicates significant at 5% level of probability

** indicates significant at 1% level of probability

Appendix VII : Analysis of variance (mean square) of number of grasses per plot at different DAS

Sources of variation	Degrees of freedom	Mean Square		
		15 DAS	25 DAS	35 DAS
Treatment	6	30.71	830.26 *	1363.19*
Replication	2	8.71	190.33	88.61
Error	12	48.04	108.22	74.28

* indicates significant at 5% level of probability

** indicates significant at 1% level of probability

Appendix VIII : Analysis of variance (mean square) of number of sedge weed per plot at different DAS

Sources of variation	Degrees of freedom	Mean Square		
		15 DAS	25 DAS	35 DAS
Treatment	6	187.56	2192.60*	3672.22*
Replication	2	174.5	841	1064.61
Error	12	111.56	294.88	495.5

* indicates significant at 5% level of probability

** indicates significant at 1% level of probability

Appendix IX : Analysis of variance (mean square) of number of broad leaf weed per plot at different DAS

Sources of variation	Degrees of freedom	Mean Square		
		15 DAS	25 DAS	35 DAS
Treatment	6	1109.96	1805.74*	2054.65*
Replication	2	24.57	83.47	28.42
Error	12	23.51	62.86	286.65

* indicates significant at 5% level of probability

** indicates significant at 1% level of probability

Appendix X : Analysis of variance (mean square) of number of total weed per plot at different DAS

Sources of variation	Degrees of freedom	Mean Square		
		15 DAS	25 DAS	35 DAS
Treatment	6	295.71	2875.56*	6424.85*
Replication	2	29.47	377.28	353.71
Error	12	138.8	605.06	1050.04

* indicates significant at 5% level of probability

** indicates significant at 1% level of probability

Appendix XI : Analysis of variance (mean square) of weed dry weight per square meter at different DAS

Sources of variation	Degrees of freedom	Mean Square		
		15 DAS	25 DAS	35 DAS
Treatment	6	56.88889	1620.27*	4477.984*
Replication	2	3.047619	61	19.19048
Error	12	16.43651	40.38889	25.9127

* indicates significant at 5% level of probability

** indicates significant at 1% level of probability

Appendix XII : Analysis of variance (mean square) of weed control efficiency for grass weeds

Source of variation	Degree of freedom	Mean square	
		25 DAS	35 DAS
Treatment	7	1950.573	3548.962049
Replication	2	12.19557	2.454538889
Error	12	1.839106	0.459658889

* indicates significant at 5% level of probability

** indicates significant at 1% level of probability

Appendix XIII : Analysis of variance (mean square) of weed control efficiency for sedge weeds at different DAS

Source of variation	Degree of freedom	Mean square	
		25 DAS	35 DAS
Treatment	7	3466.113763	3962.395625
Replication	2	9.274898341	2.141418977
Error	12	3.417334391	0.41553002

* indicates significant at 5% level of probability

** indicates significant at 1% level of probability

Appendix XIV : Analysis of variance (mean square) of control efficiency for broad leaved weeds

Source of variation	Degree of freedom	Mean square	
		25 DAS	35 DAS
Treatment	7	218.9529101	1568.330789
Replication	2	0.509967234	1.849279412
Error	12	1.470016641	0.528405205

* indicates significant at 5% level of probability

** indicates significant at 1% level of probability

Appendix XV : Analysis of variance (mean square) of weed control efficiency for total weeds at different DAS

Source of variation	Degree of freedom	Mean square	
		25 DAS	35 DAS
Treatment	7	1708.909	213.0783
Replication	2	0.660756	2.095074
Error	12	0.338661	0.58631

* indicates significant at 5% level of probability

** indicates significant at 1% level of probability

Appendix XVI : Analysis of variance (mean square) of different yield contributing characters

Sources of variation	Degrees of freedom	Mean Square					
		No. of. Pod per plant	Pod length	Shell weight per square meter	1000 grain weight	yield per square meter	yield per hectare
Treatment	6	1578.85*	0.044	647.08*	48.47	4955.36*	4955.36*
Replication	2	1268.90*	0.15	309.589	21.15	1092.7	1092.7
Error	12	354.9	0.1361	174.86	20.38	829.02	829.03

** indicates significant at 1% level of probability

** indicates significant at 1% level of probability



Picture 1: Germination of Mungbean



Picture 2: Field View





Picture 3: Affected plants due to 2,4-D

Appendix XVIII : Experimental ayout

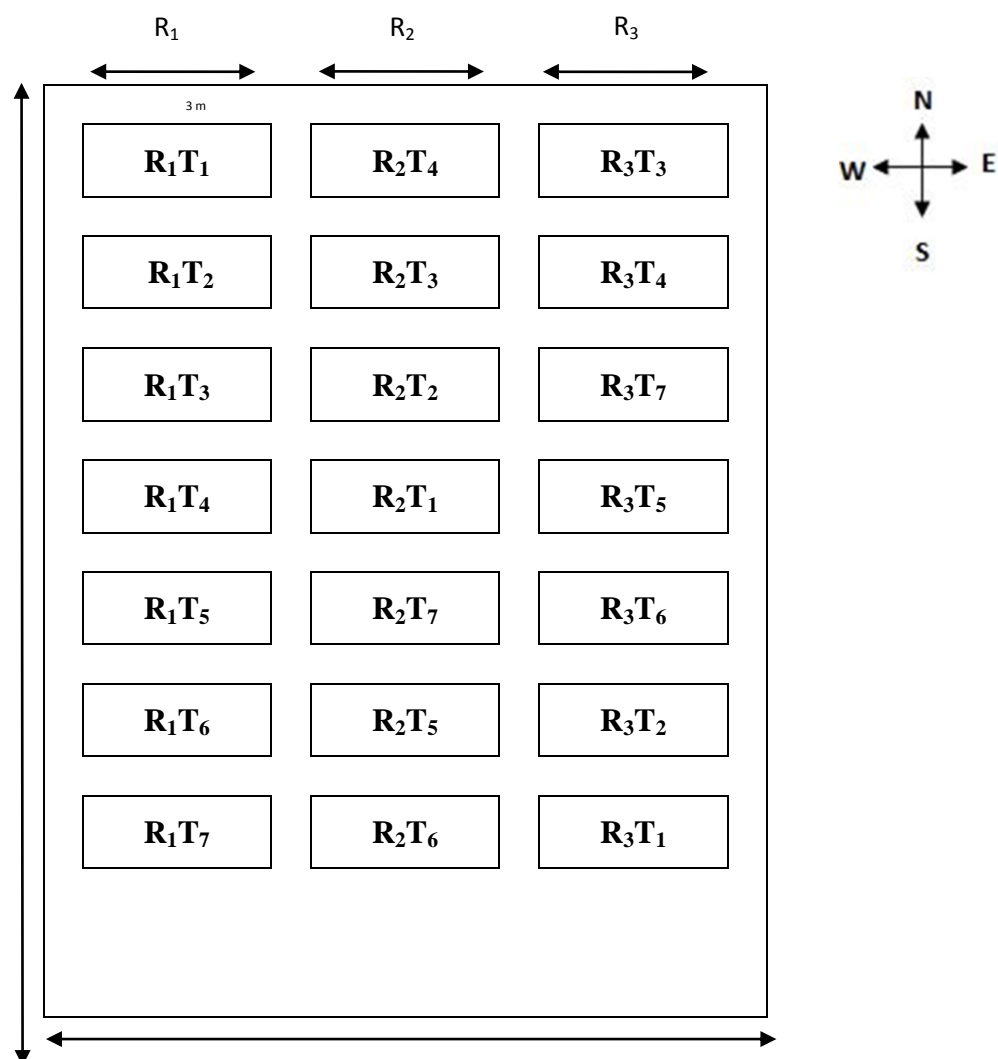

Number of treatment: 8

Replication: 3

Total Plot: 24

Plot to plot = 0.5 m

Block to block = 0.75 m

Plot Area: $3 \times 2 = 6 \text{ m}^2$

Plant to plant = 10 cm

Row to row = 30 cm

R1 = Block/ Replication 1

R2 = Block/ Replication 2

R3= Block/ Replication 3

T₁= Weedy check

T₂ = Spraying of Pull 5 EC @ 550ml/ha at 15 and 25 DAS

T₃ = Spraying of Pull 5 EC @ 600ml/ha at 15 and 25 DAS

T₄ = Spraying of Pull 5 EC @ 650ml/ha at 15 and 25 DAS

T₅ = Spraying of Pull 5 EC @ 700ml/ha at 15 and 25 DAS

T₆ = Spraying of Pull 5 EC @ 750ml/ha at 15 and 25 DAS

T₇ = Spraying of 2,4-D @ 650 ml/ha at 15 and 25 DAS